



Smart Classroom Attendance System Using RFID Module

Mandar Kokate, Premraj Shinde, Pavan Gund, Swarali Baravkar,
Shubhankit Sharma and Shishupal Yelgatte

EasyChair preprints are intended for rapid dissemination of research results and are integrated with the rest of EasyChair.

May 24, 2022

Smart Classroom Attendance Using RFID Module

Mandar Kokate
Dept. Of Electrical Engineering
NBN Sinhgad School Of Engineering,
Pune, Maharashtra, India
mandar.kokate2000@gmail.com

Pavan Gund
Dept. Of Electrical Engineering
NBN Sinhgad School Of Engineering,
Pune, Maharashtra, India
pavangund22@gmail.com

Shubhankit Sharma
Dept. Of Electrical Engineering
NBN Sinhgad School Of Engineering,
Pune, Maharashtra, India
shubhankitsharma5@gmail.com

Premraj Shinde
Dept. Of Electrical Engineering
NBN Sinhgad School Of Engineering,
Pune, Maharashtra, India
premrshinde704@gmail.com

Swarali Baravkar
Dept. Of Electrical Engineering
NBN Sinhgad School Of Engineering,
Pune, Maharashtra, India
swaralibaravkar@gmail.com

Prof. Shishupal Yelgatte
Dept. Of Electrical Engineering
NBN Sinhgad School Of Engineering,
Pune, Maharashtra, India
sdylgatte@gmail.com

1. Abstract

The world is leading to the edge of the automation. Automation also consist upgradation of the technologies. In this era the RFID (Radio Frequency Identification) is one of the best contactless communication system. It is nothing but the interfacing of RFID with Arduino. It can read the wireless data, and also store it. In this research, we proposed an automatic attendance by using RFID . In this research when the student card brought close to the RFID module, it reads the card data, verify the data with system, and stored it in its internal memory.

Also, we used IR sensors to count the total number of students entered in the class. So that will be helpful to recognize total number of students present in the classroom & actual RFID tag scanned by the reader which finds out the poxy in system.

Keywords: Attendance System, Radio frequency identification technology, Arduino, Liquid crystal display, IR sensors, RTC module.

2. Introduction

Main concept behind radio frequency based attendance system is to take the attendance. RFID card has to be shown in front of RFID reader, and then the attendance of the person is noted down in the microcontroller memory. RFID based attendance system is one of the solutions to address the problem of student security by increasing the system

efficiency instead of photo ID card. It also helps to take the attendance of the workers at their working place. Its ability to uniquely identify

each person based on their RFID tag type of ID card make the process of allowing security access easier, faster and secure as compare to traditional method.

The card holder only needs to place their card on the reader and while entering in the classroom and the IR sensors will count the number of students.

3. Literature Review

1. T.S.Lim , S.C.Sim, M.M. Mansor “RFID based attendance system ”, University of multimedia Malacca, Malaysia, 2009. In this paper, the system is takes automatic attendance of students by using RFID.
2. Karwan Jacksi, Falah Ibrahim, Shahab Ali, “Student Attendance Management System”, University of Zakho, Iraq, 2018. In this paper, the system is designed in a way that can differentiate the hours of theoretical and practical lessons since the rate of them is different for calculating the percentages of the student’s absence.
3. Ekta Chhatar, Heeral Chauhan, Shubham Gokhale, Sompurna Mukherjee, Prof. Nikhil Jha, “Survey on Student Attendance Management System”, S.B. Jain Institute of Technology, Management and Research, Nagpur, 2016. In this paper, the system deals with the maintenance of the students attendance. It generates the attendance of the student on the basis of presence and absence in class. The staffs will be provided with the separate username & password.
4. “Web Based Student Information Management”, S.R.Bharamagoudar et al., this paper assist in automating the existing manual system. It can be monitored and controlled

remotely. This paper provides accurate information always. All years together gathered information can be saved and can be accessed at any time. The purpose is to design a Automatic Attendance which contains upto date information of the student. That should improve efficiency of college record management.

5. "Online Student Attendance System", P. N. Garad et al, in this project, we gave access to three user i.e. Admin, Student. In this project teachers or the admin will be filling attendance. They will have privilege to fill attendance form, update attendance form, send message to the guardian's account whose child is absent, also those attendance is less than 75%, and they also have privilege to send message to the students whose fees are pending. He staff can also view the message whenever they want and also can modify the details of students.
6. Zahraa Salah Dhaief, Department of Computer Science, College of Education, AL-Mustansiriyah University, Baghdad-Iraq "People counting technology".

4. Working

Infrared Motion Sensors: Two IR sensors are required at the door of the classroom. By using the position of two IR sensors (IR1 & IR2) fixed at the both sides of the door limb. When the student entered in the class the IR1 and IR2 sensors cuts the signal respectively. And it will execute the command n+1. Likewise, while student leave the classroom IR2 & IR1 cuts the signal respectively. And it will execute the command n-1.

Each student has RFID tag attached with their Student ID card. There is a RFID reader has been maintained for connection between RFID and the Arduino. The RFID reader is placed at the classroom. Whenever students enter the classroom RFID reader read the RFID tag and it store the all information (Entry time, Name, etc.) of students into database and maintain the system.

Here admin of this system can view all data using the software interface by retrieving information from database without any difficulties not like traditional system.

The aim of this project is to design an RFID Technology based Attendance System using Arduino, in which the attendance of students is automatically recorded with the help of a card. When this circuit is powered ON, initially the Arduino will display the message on the LCD display hold the tag/card near to the reader. When the RFID reader detects the ID card, it will store the data in the Arduino. By

using suitable programming, it will convert to an excel sheet on the computer.

During this process, LCD display shows the total number of students entered in the classroom and it also shows the total RFID card/tag scanned by the reader. If there is any difference in the count of RFID tags and total number of students present in the classroom, it gives alert to the system. So that difference shows the proxy in the attendance, then teacher has to manually correct the error of the attendance.

5. Block diagram

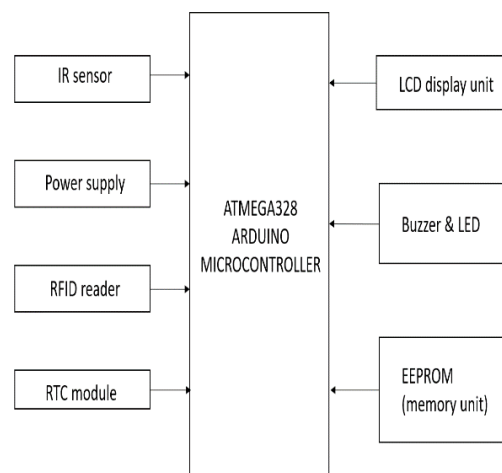

6. Flow chart of RFID Module

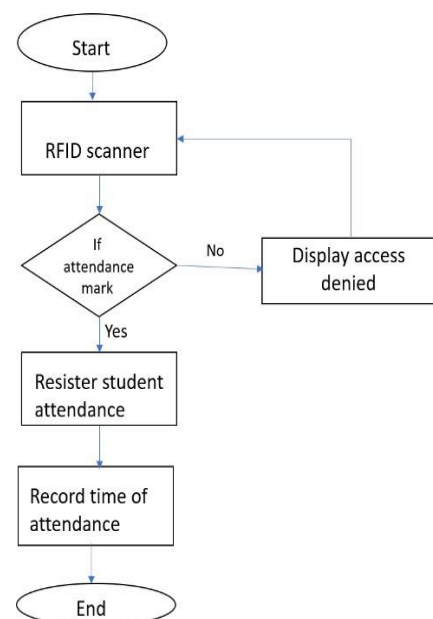

7. Flow chart for IR sensor

ENTRY:-

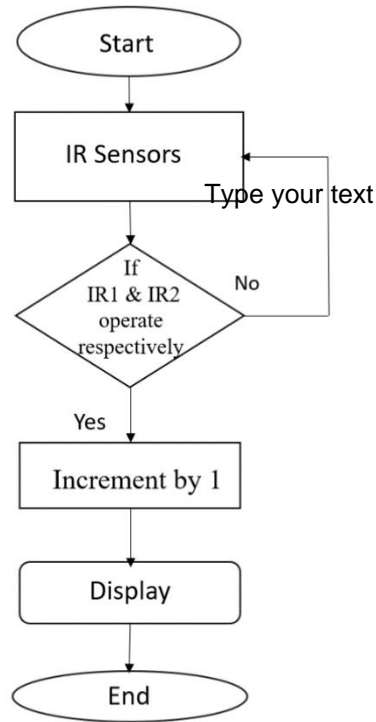

EXIT:-

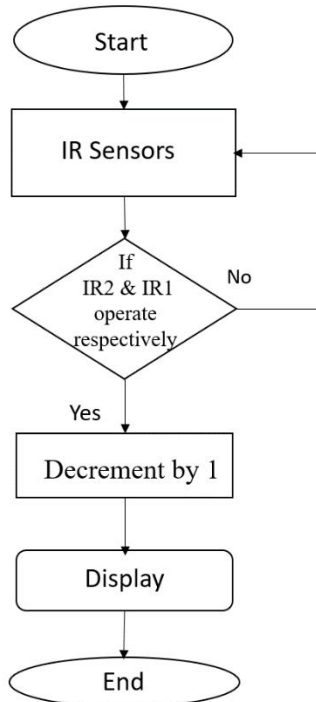

8. Results

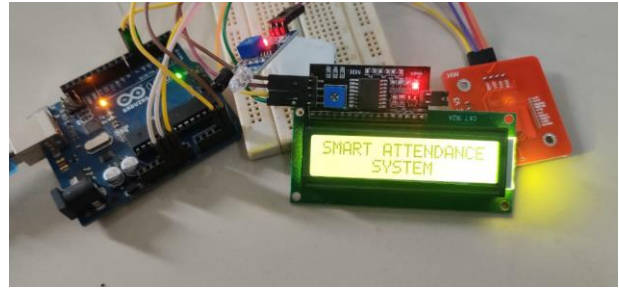

Fig. 8.1 Smart Classroom System

As the supply is given to system Project Name Smart Attendance System will be displayed on the LCD Screen.

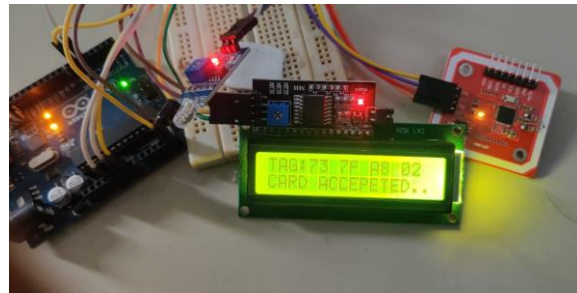

Fig. 8.2 Valid Card Accepted

After the card/tag is scanned, and if the card is valid the display shows that the card is accepted.

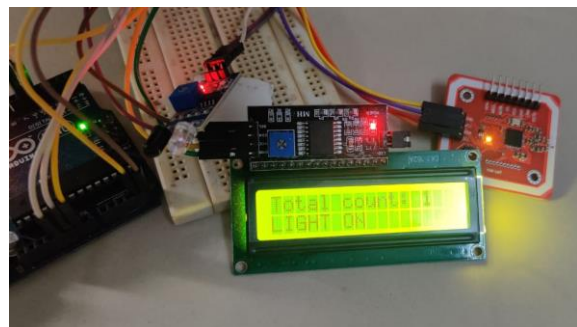

Fig. 8.3 Count Incremented

When there is difference between IR Sensors count & RFID tags count then led will glow.

9. Conclusion

The main objective to build a proxy free RFID based attendance system with the help of IR sensors counting logic is successfully achieved. This project has provided a convenient method of attendance making compared to traditional method of attendance making. This system helps to detect and notifies whenever someone tries to add a proxy. It is also user friendly and make it universal attendance system. Thus, it can be implemented in many organization, educational institute etc.

10. Acknowledgement

It is indeed a great pleasure and moment of immense satisfaction for we to present a project report on “classroom attendance system” amongst a wide panorama that provided us inspiring guidance and encouragement, we take the It is indeed a great pleasure and moment of immense satisfaction for we to present a project report on “classroom attendance system” amongst a wide panorama that provided us inspiring guidance and encouragement, we take the opportunity to thanks those who gave us their indebted assistance. We wish to extend our cordial gratitude with profound thanks to our internal guide Prof. S. D. Yelgatte for his everlasting guidance. It was his inspiration and encouragement which helped us in completing our project.

Our sincere thanks and deep gratitude to Head of Department, Prof. S. S. Patil and other faculty members; but also, to all those individuals involved both directly and indirectly for their help in all aspect of the project.

11. References

- [1] S. Abdinia, A. H. M. van Roermund, and E. Cantatore, “RFID Tag,” 2015, pp. 113– 121.
- [2] RF-ID, “RFID & Reader,” RF-ID website, 2009. [Online]. Available: <http://www.rfid.com/3rfid869/nordicuhf.html>. [Accessed: 09-Mar-2019].
- [3] A. A. Olanipekun and O. K. Boyinbode, “A RFID based automatic attendance system in

educational institutions of Nigeria,” *Int. J. Smart Home*, vol. 9, no. 12, pp. 65–74, 2015.

[4] H. D., N. Salih, A. Al, B. Al-Sadawi, and H. Alsharqi, “Attendance and Information System using RFID and Web-Based Application for Academic Sector,” *Int. J. Adv. Computer. Sci. Appl.*, vol. 9, no. 1, pp. 266–274, 2018.

[5] M. M. M. Thein, C. M. Nwe, and H. M. Tun, “Students ’ Attendance Management System Based On RFID And Fingerprint Reader,” *Int. J. Sci. Technol. Res.*, 2015.

[6] Y. Mishra, G. K. Marwah, and S. Verma, “Arduino Based Smart RFID Security and Attendance System with Audio Acknowledgement,” vol. 4, no. 01, pp. 363–367, 2015.

[7] T. Sanjay, “Attendance Management system,” *Dev. A. A.* (2014). *Attend. Manag. Syst.* 4(7), 541–543., vol. 4, no. 7, pp. 541–543,2014