



IoT Based Smart Mirror Using Raspberry Pi 4 and YOLO Algorithm: a Novel Framework for Interactive Display

V Viswanatha, R K Chandana and A C Ramachandra

EasyChair preprints are intended for rapid dissemination of research results and are integrated with the rest of EasyChair.

January 3, 2023

RESEARCH ARTICLE

 OPEN ACCESS**Received:** 06-08-2022**Accepted:** 12-09-2022**Published:** 17-10-2022

Citation: Viswanatha V, Chandana RK, Ramachandra AC (2022) IoT Based Smart Mirror Using Raspberry Pi 4 and YOLO Algorithm: A Novel Framework for Interactive Display. Indian Journal of Science and Technology 15(39): 2011-2020. <https://doi.org/10.17485/IJST/V15i39.1627>

* **Corresponding author.**

viswas779@gmail.com

Funding: The research was funded by Nitte Meenakshi Institute of Technology, Bangalore

Competing Interests: None

Copyright: © 2022 Viswanatha et al. This is an open access article distributed under the terms of the [Creative Commons Attribution License](https://creativecommons.org/licenses/by/4.0/), which permits unrestricted use, distribution, and reproduction in any medium, provided the original author and source are credited.

Published By Indian Society for Education and Environment ([iSee](https://www.isee.org/))

ISSN

Print: 0974-6846

Electronic: 0974-5645

IoT Based Smart Mirror Using Raspberry Pi 4 and YOLO Algorithm: A Novel Framework for Interactive Display

V Viswanatha^{1*}, R K Chandana², A C Ramachandra³

1 Asst. Professor, Electronics and Communication Engineering Department, Nitte Meenakshi Institute of Technology, Bangalore, India

2 M.Tech. Student, Electronics and Communication Engineering Department, Nitte Meenakshi Institute of Technology, Bangalore, India

3 Professor and Head, Electronics, Electronics and Communication Engineering Department, Nitte Meenakshi Institute of Technology, India

Abstract

Objectives: The primary goal of this device is to support the user in a variety of ways, and by enabling communication between the user and the gadget, we can demonstrate the user's control over the location where the device will be Built and set up the home environment for the human detection using You Only Look Once (YOLO) algorithm. **Methods:** The technology is made to show the current news, weather, and temperature on the mirror. The technology is primarily intended to be used as an intrusion detection system and for human monitoring. YOLO algorithm is used to find the object in the given image. The suggested design is envisioned as a collection of components that can be utilized to provide security as well as simply display information on a screen. The system is created utilizing Python programming and hardware components such as Raspberry Pi 3 model, a microphone, a touch screen, a mobile device, a camera, and passive infrared (PIR) sensors. **Findings:** This study provides thorough information regarding the operation of a smart mirror, which enables us to perform all necessary actions or tasks that we perform regularly and to complete them in a predetermined amount of time. Since the research is primarily intended for intrusion detection, we can also get the most out of it by using it in a specific manner. We would use it to monitor children's whereabouts. **Novelty:** This technology has a high economic value because it has so many uses and tends to help users with daily tasks. And because it is created using machine learning language and has room for artificial intelligence, even the user who uses it can add some of his remainders to the device, and it can also alert a user in the designated remainder time so that person won't miss their important meeting. As a result, this device is more valuable, useful, and collectively beneficial. This technology will produce a finished product with the highest level of accuracy and precision.

Keywords: Smart mirror; Feeds; Human Monitoring; YOLO Algorithm; Interactive system; Object Detection; IoT

1 Introduction

In the modern world, practically every piece of equipment has been transformed into a smart device thanks to technological advancements. From everyday objects to the most cutting-edge electronic equipment, almost all electronics are becoming intelligent. Modern products' "smart" characteristics are a result of the inclusion of prediction algorithms and artificial intelligence (AI). In light of this, a smart device that may present personalized data displayed on the screen and behave intelligently by offering security as required is suggested. The technology can be used to provide security in a deployed setting. It can also keep an eye on people. Typically, people use mirrors to get ready for the day's work. According to some research, an average person spends at least 28 minutes every day looking in the mirror^(1,2). The primary idea is to use this time to notify a person of the most recent news, weather, date, time, and calendar adjustments as a result. It is quite difficult to find time to check the news and other updates, like the weather, because of how hectic life has become. Additionally, there is a lack of a package that compiles and shows all of this information on a single screen. The suggested system is interactive, that Smart Mirror even as you are getting ready to display relevant and necessary information. There have been many different systems offered up to this point, but the way the product is used makes a significant difference⁽³⁻⁵⁾. The majority of the items on the market are informational, passive, and barely interactive. Such a system's main function is to show information on the mirror, and it may be operated with any type of input, including keyboard, or mobile instructions. A two-way acrylic sheet, a mirror, an LCD (liquid crystal display), or an LED display can all be used as displays for these smart mirrors. The proposed system is capable of responding to orders issued from mobile devices⁽⁶⁻⁸⁾. The proposed work functions as a security precaution, a tool for human monitoring, and a means of information dissemination. The system helps in detecting intrusions. The camera attached to the Raspberry Pi is triggered as soon as the PIR (Passive Infrared Sensor) sensor detects activity, motion, or movement. The camera attached to the Raspberry Pi4 latest model is taking pictures. Using image processing methods like Background Subtraction and the Simple Frame Difference Approach, the invasion is found. The administrator of the mirror will receive notification of the incursion through an alert message along with a photo of the offender.

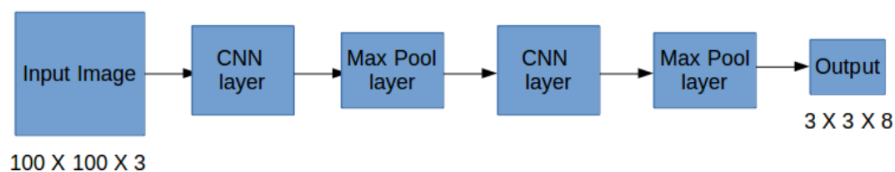

Fig 1. YOLO algorithm architecture

Additionally, the technology is being developed for human monitoring. Families are becoming smaller in size today. Thus, it becomes challenging to keep an eye on kids, the elderly, and the ill⁽⁹⁾. It is challenging to watch over children when they get home from school due to busy schedules and working parents. An alarm message will be issued to the Smart Mirror administrator if the person moves out of the camera's field of view. The proposed methodology will be useful for employee monitoring in jewelry stores, prisoner monitoring in jails, and monitoring prisoners in hospitals^{(10)(11,12)}.

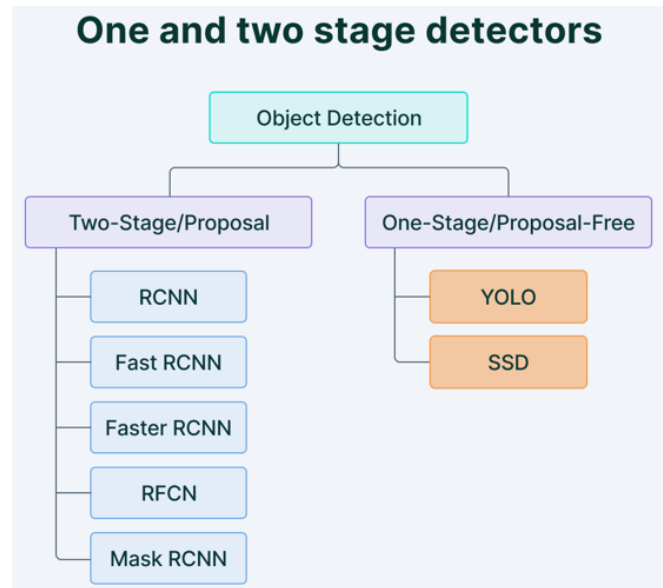

Fig 2. Object detection Algorithms

Various algorithms as shown in Figure 2 are used for object detection, including Retina-Net, rapid R-CNN, and Single-Shot Multi-Box Detector (SSD). These methods have addressed the problems of data scarcity and modeling in object detection, however, they cannot find objects in a single algorithm run. Due to its superior performance to the mentioned object detection techniques, the YOLO algorithm as shown in Figure 1 has grown in popularity⁽¹³⁾⁽¹⁴⁾.

In⁽¹⁾ has worked on employing a smart mirror to implement a home automation system. Therefore, by taking into account the home automation method, they have effectively implemented the criteria, and through this method, they are only successful in making the smart mirror be used for home automation, such as using for controlling home appliances and also can be used for just displaying information over the screen and can only be used for home appliances. In⁽¹⁵⁾ has worked on the design and implementation of Smart Mirror as a Personal Assistant Using Raspberry Pi, has worked on the same project. The smart mirror serves as a personal assistant by showing information that is customized and the weather. With few jobs, this is solely utilized to display information on the screen.

2 Methodology

Given that the smart mirror is a bi-dimensional concept, we are aware that a highly advanced architectural design is required to make it function properly and efficiently. So we came up with the architecture which best suits the purpose according to the action. Older models that we have seen are only capable of a restricted number of functions and lack security measures. The brains of the suggested model are Raspberry Pi. An element of synchronization is the Mirror State. Syncing the devices that are connected to the heart section is the primary purpose of the software component. Whenever commands are given to the Raspberry Pi, the device initially enters the mirror state where it evaluates the instructions. The proposed method follows the login method as shown in Figure 3. When a command is issued while another is currently being executed, the mirror state determines whether the second command can be carried out or not. The preceding introductory section explains other working details.

The foundation of the proposed architecture is the Raspberry Pi, and the system is designed so that the identified user has access to all preloaded notifications, allowing him to quickly access the most recent news or web services and receive all other necessary services. The architecture operates as follows: first, the camera is placed in the appropriate location to capture the required image. Next, the image is processed inside a raspberry pi, which serves as the architecture's central processing unit. This device performs all necessary calculations, identifies the necessary portions, and divides the processed information to carry out two different tasks: intrusion detection and human detection. As a result, it will first recognize a person in the image, process the pre-loaded data, and compare it to the taken image; if the match synchronizes, it will go to the next level. Using PIR sensors, intrusion detection will simply feel the object and alert if it is an unauthorized one. As a result, all of the information that is already present in the device is processed and displayed on the screen. It can also be controlled via voice commands, and

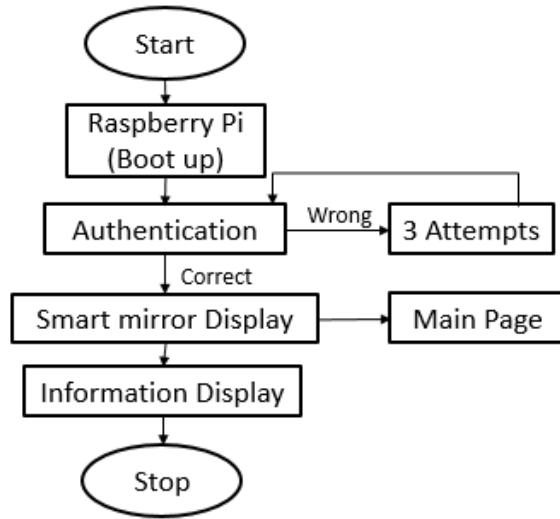

Fig 3. Login module

in this case, commands can also be supplied through mobile phones using the appropriate interface.

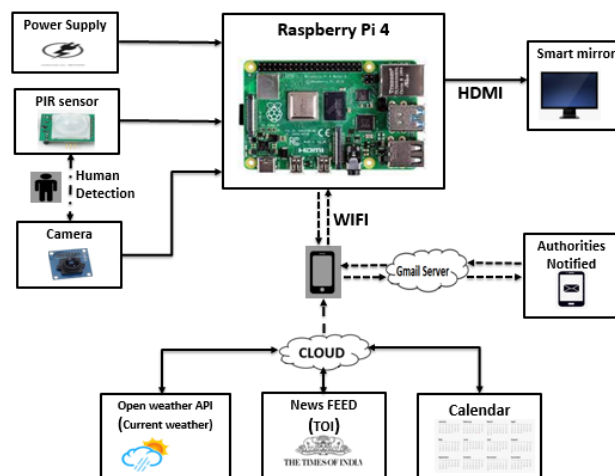

Fig 4. Proposed architecture

This proposed architecture shown in Figure 4 uses raspberry pi as the core of it, and we design a system in such a way that all the notifications which are preloaded are available to the defined user so that he can avail of the latest news or the web services in an instant, so the defined user can avail all the necessary service. So the architecture works basically in the following way, at first, the camera will be placed in the required area so that it can capture the necessary image, and the captured image will be processed inside a raspberry pi which will be in the core and it does all the necessary calculations and it identifies the required portions and it will split the processed information to perform the two actions they are human detection and intrusion detection so at first it will identify a person in the image and it will process the pre-loaded data and matches the captured image so if the match synchronizes then it will move forward to the next stage, and in the intrusion detection, it will just sense the object and alerts if the object is an unauthorized one using PIR sensors. So here it can also be controlled using the mobile phones using the respective interface, and all the information which are already included in the device is processed and displayed over the screen.

Yolo, a machine learning technique, is the algorithm utilized for human detection, and Python coding is also used. Due to the use of Convolutional Layers, YOLO is an FCN (completely convolutional network). We employ skip connections, up-sampling layers, and about 75 convolutional layers. There is no pooling employed, and a convolutional layer with a stride of 2 is used to down-sample the features of the maps. Because it is an FCN, YOLO is independent of the input image's size. The network must reduce the image's sample size by a factor equal to the network's stride. For instance, if the network's stride is 32, an input image with a size of 416×416 will result in an output with a size of 13×13 . The convolutional layers learned features are accepted by the classifier/ regression⁽¹⁶⁻¹⁸⁾. The actual detection prediction is performed by this technique. In YOLO, a neural layer that employs 1×1 convolutions performs the actual prediction. An actual feature map is a result. Due to the use of 1×1 convolutions, the size of the prediction map will be precisely the same as the size of the feature map. In the case of YOLO v3, each cell in the prediction map will forecast a specified number of bounding boxes⁽¹⁹⁾. The formulas for obtaining bounding box predictions are shown in Figure 4.

The security and human monitoring module have an intrusion detection feature.

$$\begin{aligned}
 b_x &= \sigma(t_x) + c_x \\
 b_y &= \sigma(t_y) + c_y \\
 b_w &= p_w e^{t_w} \\
 b_h &= p_h e^{t_h}
 \end{aligned}$$

Fig 5. Bounding Box equation

The bounding box followed for the grid cell is as shown in Figure 5. b_w and b_h represent the prediction's width and height, whereas b_x and b_y are the predictions x and y center coordinates. The network outputs are denoted by the words t_x , t_y , t_w , and t_h . The top-left grid coordinates are represented by the words c_x and c_y . p_w and p_h stand for the box's anchor dimensions. Figure 5 explains the real procedure of detection and prediction^{(20,21) (22)}.

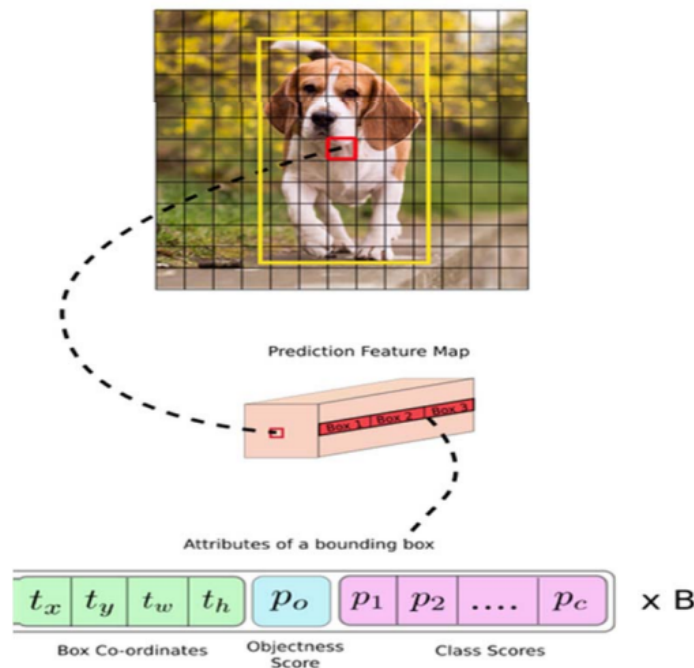

Fig 6. Actual Detection Prediction Process

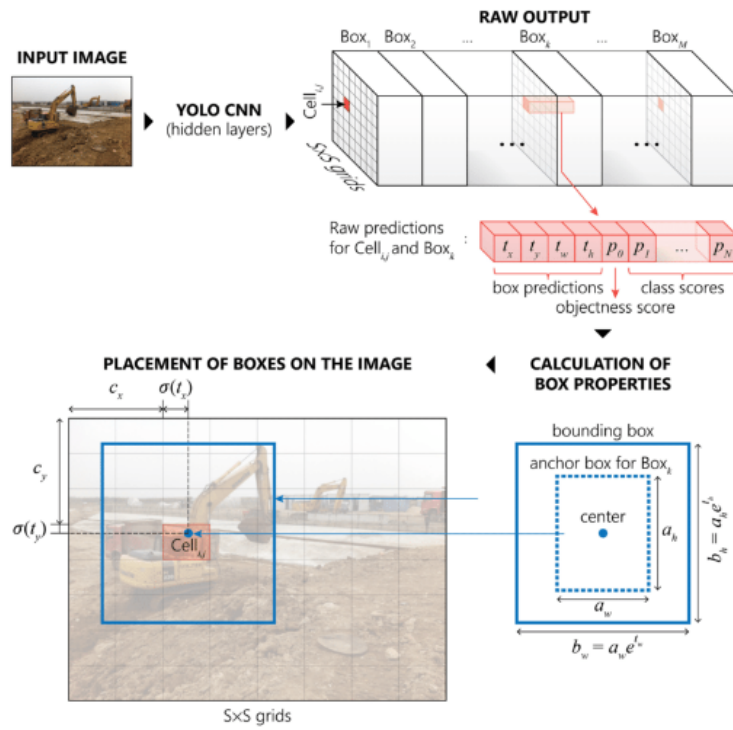

Fig 7. Schematic Diagram of the YOLO algorithm

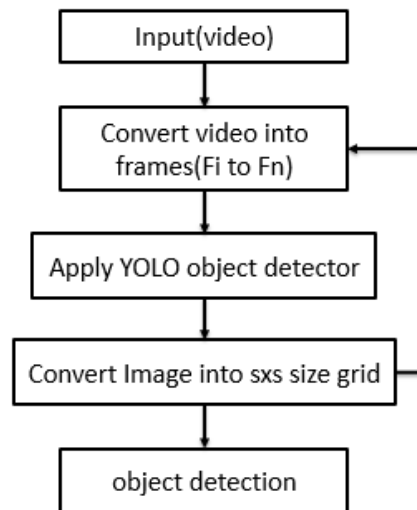

Fig 8. Human Detection Process

The Figure 8 illustrates the human detection process implementation. At first, the face will be detected and the face will be diagnosed and there will be a suitable alignment of the captured photo will be processed into various angles and there will be a check on matches and the final aligned image will go through an anti-spoofing process in which irregularities or imperfections will be checked. The processed face image after anti-spoofing, the image will be fermented into several copies and the irregularities will be removed and this image is made suitable for further process and this process is referred to as face processing⁽²³⁾. Then there will be two further methods they are training and testing, so in the training, the processed image will undergo feature extraction, and then it will undergo two processes namely a Euclidian distance process and angular distance so these two effectively contribute towards finding out the loss function which is referred as training and now the trained image will undergo feature extraction and then it will be focused on testing in this it will go through two processes namely Euclidian distance, and metric calculation and after these processes it will finally lead to a method called face matching so that the concluded process will be a detected face image. So these were the detailed proposed architecture in order to contribute towards the successful working of smart mirrors^(24,25).

3 Results and Discussion

This section has discussed the testing results based on the experiments conducted on hardware. The input in our smart mirror is mainly through the camera and PIR sensor. Whenever the movement of humans including animals is detected by the PIR sensor, the camera will get activated and the image is captured. Now the captured image is processed by the YOLO algorithm for object detection in the captured image. With the YOLO algorithm, the bounding box is created for each object present in the image as shown in Figure 11. In this prototype, there is a control mechanism set with a touch sensor connected as an external input device to the Raspberry Pi 4 board. In this control mechanism, the captured image is sent to the owner of the house via email only when the touch sensor is enabled (touching the touch sensor with a finger) by the owner. This control mechanism avoids sending emails when the object of the owner/owners is detected. The output is generated from the smart mirror as a text feature displayed on the mirror and sending the image with object detected via an email to the owner. The text feature includes weather, time, calendar, news headlines, etc. Of course, there exists already automated systems that use Object detection techniques to detect the object in a given image; such object detection techniques have used the classic CNN algorithms. Unlike the existing algorithms, we are using the latest Yolo algorithm that uses YOLO v5 version. It is a new and full-fledged algorithm to detect the objects quickly with more accuracy so that detecting speed will be improved and action will be done quickly. Therefore, this smart mirror is a blend of many strategies, making it useful in a variety of everyday settings. As we use this even to monitor specific things, such as in the home, we would actually make it to monitor children who will be in the room, so that if a child moves away from a room, the user will get information about it to his mobile, or we can prevent a child from moving away from a room by employing a door-latch system. As a result, if we use a smart mirror in an office setting, we can actually increase our privacy and security. With an authorized entry or exit system, we can choose whether to allow or reject a stranger's entry into our workspace or cabin. We will also receive a message if a stranger enters our cabin without our permission. So one can gain from using this equipment as well.

The prototype of the hardware model is shown in Figure 9 and the smart mirror output is shown in Figure 10 as a result of the porotype model. The smart mirror which has been built can displays date, time, and weather forecast information along with current weather information. At the left, on the top, the date and time information is displayed. Below of it, there is a holiday list. On the right side, there is current weather information along with weather forecast information. At the bottom, there are news headlines that change for every ten seconds.

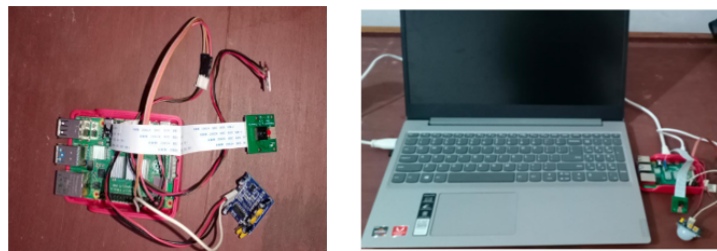

Fig 9. Hardware Setup

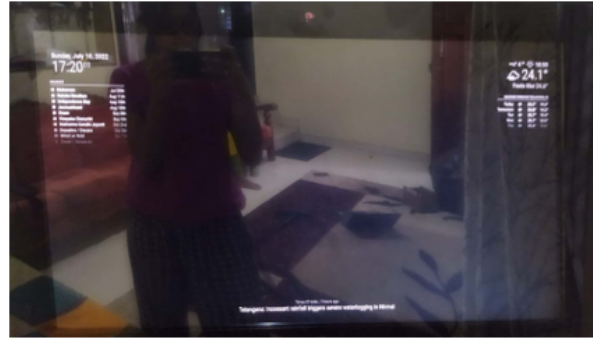

Fig 10. Smart mirror output

Figure 11 illustrates how the human in the input image is recognized by its classes and assigns each object by its tag and has dimensions on the detected Image.

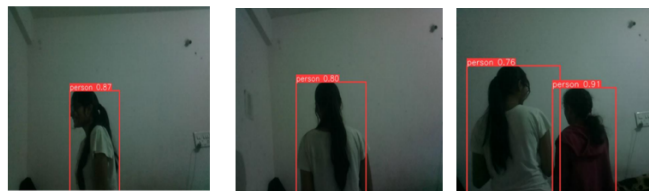

Fig 11. Yolo object Detection output

Figure 12 illustrates how each object by its tag has dimensions on the detected image and sends the message to the owner via email.

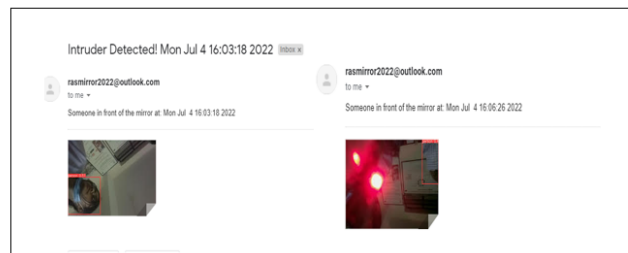

Fig 12. Authorities Notified via Email

4 Conclusion

We created a future smart mirror that enables seamless user engagement with ambient home services. A flat LED display monitor serves as the mirror display and shows all the pertinent data that is beneficial to the user. To show how our work functions, we created a prototype. Overall, the prototype offers a flexible framework that may be used to give the user even more capabilities. In our upcoming work, we'll explore how to best deliver service experiences in the home environment by utilizing the user's context and the environment. By including further functionality, such as integrated light settings, voice processing, etc., the system can be made far more useful to the users. The primary goal of the suggested work is to create a product packed with as many features as is practical. The system was not only designed as a way to convey information but also as a system that is interactive and actively used to provide security. The same can be done with a smart mirror. The system might be suggested as a commercial item. That is a potential area of further investigation in the suggested system by synthetic intelligence. The identical mirror may be enlarged to regulate the lighting and home appliances. To boost the amount of Face detection can be used for authentication in terms of security. It is also possible to test the system with various intrusion and human monitoring methods to improve the precision of the system. With the help of this thesis and based on the outcomes of the experiments, we can recognize each person individually and pinpoint its specific placement in the image along the x and y-axis. This study evaluates the efficacy of each strategy for Human detection and identification while also providing experimental results for several approaches.

5 Future scope

The upcoming prototype has a lot of potentials and is probably functionally robust. Voice commands are used to move between views, while gestures are used to interact with the content. We may apply the functionality to a glass material rather than keeping it isolated to a house. In order to be used in a variety of settings, one might install this function on a glass table that could be used in a company. This would enable users to view many websites' notifications on a single screen at once. The ability to put up this feature in public areas is another application.

In future work, many more third-party modules can be added to the mirror. Also, our modules can be created using magic mirror software. The mirror becomes more interactive if the number of modules added is more. If we are ready to compromise on the cost, the camera can also be installed into the mirror. Also, the mirror can be made as a touch screen, where the user can use the mirror like a touch screen smartphone. These mirrors can also be used in malls, where people can easily see how an outfit looks on them, without actually wearing it. So this helps in virtual dressing in malls. These mirrors can also be used in industries and supermarkets to give comfort to the user's information.

6 Acknowledgement

The research was funded by Nitte Meenakshi Institute of Technology, Bangalore.

References

- 1) Kiran SCVLSR, Naresh Babu Kakarla, Banoth Praveen Naik, "Implementation of Home automation system using Smart Mirror". *International Journal of Innovative Research in Computer and Communication Engineering*. 2018;6. Available from: <https://www.irjet.net/archives/V8/i5/IRJET-V8I5430.pdf>.
- 2) Kumbhar PY, Mulla A, Kanagi P, Kanagi R, Shah R. Smart Mirror Using Raspberry. *Emerging Science And Technology*. 2018;5(4). Available from: <https://ijrest.net/downloads/volume-5/issue-4/pid-ijrest-54201810>.
- 3) Ajayan J, Kumar P, Saravanan S, Sivadharini S, Sophia R. Development of Smart Mirror using Raspberry-Pi 3 for Interactive Multimedia. *12th International conference on Recent Innovations in Science and Management ICRISEM'-2019*. 2019. Available from: https://doi.org/10.1007/978-981-15-0111-1_10.
- 4) Kamineni BT, Sundari A, Prakash K, Suparna R, Nayak K. Using Raspberry Pi to style Smart Mirror Applications. *IJETST*. 2019;05:6585–6589. Available from: <https://igmpublication.org/ijetst.in/index.php/ijetst/article/view/1258>.
- 5) Jagdish A, Pateljayshri T, Sonal DS, Sangaleharshada A, Dokhale. A Review Paper Design and Development of a sensible Mirror Using Raspberry Pi. *International Journal of engineering Invention (IJESI)*. 2019;7:40–43. Available from: [http://www.ijesi.org/papers/Vol\(7\)i4/Version-1/F0704014043](http://www.ijesi.org/papers/Vol(7)i4/Version-1/F0704014043).
- 6) Chandel S, Mandwarya A, Ushasukhanya S. Implementation of Magic Mirror Using Raspberry Pi 3". *International Journal of Pure and applied math*. 2018;118(22):451–455. Available from: <https://acadpubl.eu/hub/2018-118-22/articles/22a/65>.
- 7) Yong S, Liqing G, Ke D. Design of Smart Mirror supported Raspberry Pi. *JETST*. 2019;05:6585–6589. Available from: <https://ieeexplore.ieee.org/document/>.
- 8) Jin K, Deng X, Huang Z, Chen S. Design of Smart Mirror supported Raspberry Pi. *2nd IEEE Advanced Information Management, Communicates, Electronic and Automation Control Conference*. 2018. Available from: <https://doi.org/10.1109/IMCEC.2018.8469570>.
- 9) Assudani M, Kazi AS, Sherke PO, Dwivedi SV, Shaikh ZS. Hermione 1.0". A voice Based Home Assistant System. *National Conference on Advances in Engineering and engineering (NCAEAS) 29th*. 2019. Available from: <https://1library.net/document/qmojmn5y-a-oehermione-a-voice-based-home-assistant-system.html>.
- 10) Yang BS, Kang TW, Choi YS, Jung JW. Error-Resistant Movement Detection Algorithm for the Elderly with Smart Mirror. *Applied Sciences*. 2022;12(14):7024–7024. Available from: <https://doi.org/10.3390/app12147024>.

- 11) Ajayan J, Kumar P, Saravanan S, Sivadharini S, Sophia R. Development of Smart Mirror using Raspberry-Pi.
- 12) Kumbhar PY, Mulla A, Kanagi P, Shah R. Smart Mirror Using Raspberry. *In Emerging Science And Technology*. 2019;5(4). Available from: <https://ijrest.net/downloads/volume-5/issue-4/pid-ijrest-54201810>.
- 13) Kawale J, Chaudhari P. IoT based Design of Intelligent Mirror using Raspberry Pi. *2019 IEEE 5th International Conference for Convergence in Technology (I2CT)*. 2019. Available from: <https://doi.org/10.1109/I2CT45611.2019.9033738>.
- 14) Sahana S, Shraddha M, Phalguni MP, Shashank RK, Aditya CR, Lavanya MC. Smart Mirror using Raspberry Pi: A Survey. *2021 5th International Conference on Computing Methodologies and Communication (ICCMC)*. 2021. Available from: <https://www.scribd.com/document/583419780/Smart-Mirror-Using-Raspberry-Pi>.
- 15) Divyashree KJ, Vijaya DPA, Awasthi N. Design And Implementation Of Smart Mirror As a private Assistant Using Raspberry PI ". *International Journal of Innovative Research in Computer and Communication Engineering*. 2018;6.
- 16) Pandey AJSJRNWD. Smart Mirror: A time-saving and Affordable Assistant. *4th International Conference on Computing Communication and Automation (ICCCA)*. 2018.
- 17) Hamza M, Lohar SA, Ghulamani S, Shah A. Smart Mirror for Home and Work Environment. *2019 IEEE 6th International Conference on Engineering Technologies and Applied Sciences (ICETAS)*. 2019.
- 18) Sun Y, Geng L, Dan K. Design of Smart Mirror Based on Raspberry Pi. *Conference on Intelligent Transportation, Big Data & Smart City (ICITBS)*. 2018. Available from: <https://doi.org/10.1109/ICITBS.2018.00028>.
- 19) Anne A, 'souza; Priya Kaul D, Dhuri EPM. Ambient Intelligence Using Smart Mirror-Personalized Smart Mirror for Home Use. *2019 IEEE 5th International Conference for Convergence in Technology (I2CT)*. 2019. Available from: <https://doi.org/10.3390/s21227453>.
- 20) Mary GSJDM, Ghaannth SVJ, Kumar JD. IoT Based Voice Controlled Raspberry PI Smart Mirror. *2021 7th International Conference on Advanced Computing and Communication Systems (ICACCS)*.
- 21) Viswanatha V, Sutradhar S, Kumar S, Kumar S. Intelligent line follower robot using MSP430G2ET for industrial applications. *Helix-The Scientific Explorer| Peer Reviewed Bimonthly International Journal*. 2020;10:232–237. Available from: <https://helixscientific.pub/index.php/home/article/view/136>.
- 22) Viswanatha V, Kumari A, Kumar P. Internet of things (IoT) based multilevel drunken driving detection and prevention system using Raspberry Pi 3. *International Journal of Internet of Things and Web Services*. 2021;6.
- 23) Viswanatha V, Ramachandra AC, Reddy RVS. Bidirectional DC-DC converter circuits and smart control algorithms: a review. *Journal of Electrical Systems and Information Technology*. 2022;9:1–29.
- 24) Kumari A. Multilevel Home Security System using Arduino & GSM. *Journal for Research*. 2018;4. Available from: <https://doi.org/10.31227/osf.io/byc/jn>.
- 25) Li Z. An improved algorithm for deep learning YOLO network based on Xilinx ZYNQ FPGA. *2020 International Conference on Culture-oriented Science & Technology (ICCST)*. Available from: <https://doi.org/10.37896/JXAT14.07/315415>.