



Solution Of Inverse Problem Cauchy Type (Design) For Plane Layer

Michał Ciałkowski, Nikolai Botkin, Jan Kołodziej,
Andrzej Frąckowiak and Wiktor Hoffmann

EasyChair preprints are intended for rapid dissemination of research results and are integrated with the rest of EasyChair.

November 16, 2020

Solution Of Inverse Problem Cauchy Type (Design) For Plane Layer

Michał Ciałkowski¹, Nikolai Botkin², Jan Kołodziej³, Andrzej Frackowiak¹, and
Wiktor Hoffmann^{1[0000-0001-7446-1369]}

¹ Institute of Thermal Engineering, Poznan University of Technology

² Department of Mathematical Modelling, Technische Universität München

³ Institute of Applied Mechanics, Poznan University of Technology

Abstract. In engineering practice not always is possible the measurements of temperature on both side of wall (for example turbine casing or combustion chamber). On the other hand it is possible measurement both temperature and heat flux on outside wall. For transient heat conduction equation the measurements of temperature and heat flux supplemented by initial condition state Cauchy problem which is ill conditioned. In the paper the stable solution is obtained for Cauchy problem by using Laplace transformation and minimisation of continuity in the process of integration of convolution. Test examples confirm the proposed algorithm of solution of inverse problem. In the numerical calculations the initial temperature was equal to zero and because of insulation the outer surface of turbine causing the heat flux was also equal zero.

Keywords: Inverse heat conduction · Cauchy problem · Laplace transformation · Regularization.

1 Introduction

In thermal problems, the coefficients of governing equations such as the thermal conductivity, density and specific heat, as well as the intensity and location of internal heat sources, if they exist, and appropriate boundary and initial conditions should be specified. Such problems are referred to as ‘direct thermal problems’ and may be accurately solved by standard numerical methods since they are well-posed. However, in many practical applications which arise in engineering, a part of the boundary is not accessible for heat flux or temperature measurements. For example, the temperature or the heat flux may be seriously affected by the presence of a sensor and, hence, there is a loss of accuracy in measurement or, more simply, the surface of the body may be unsuitable for attaching a sensor to measure the temperature or the heat flux. As examples can be inner surface of turbine casing or combustion chamber. The situation when neither the heat flux nor temperature can be determined on a portion of the boundary, while both of them are prescribed on the remaining portion, leads to an ill-posed problem termed the ‘Cauchy problem’. The Cauchy problem is an ill-posed problem and it is more difficult to solve both analytically and numerically.

The Cauchy problem is not new in literature, see e.g. [1–7]. Due to its ill-posed character many approximate methods were used. In paper [1], the problem is reduced to a linear integral Volterra equation of II type which admits a unique solution. The method of fundamental solution was used in paper [2] for solving the steady Cauchy problem. In papers [3, 4], the finite difference method with Fourier transform techniques were applied. Legendre polynomials were used in paper [5] for solving 1-D Cauchy problem. The Wavelet-Galerkin and Fourier transform methods were utilized in paper [6]. The uniqueness of solution to an ill-posed Cauchy problem was considered in paper [7].

The purpose of this paper is to propose a stable solution which is obtained for Cauchy problem by using Laplace transformation and minimisation of continuity in the process of integration of splice. Test examples confirm the proposed algorithm of solution of inverse problem.

2 Fundamental Equation

For region shown on Fig. 1 the governing equation and conditions describing heat flow are the following:

- heat conduction equation (ρ - density, c - relative heat, λ - heat conduction coefficient):

$$\rho c \cdot \frac{\partial T}{\partial t} = \frac{\partial}{\partial x} \left(\lambda \frac{\partial T}{\partial x} \right), x \in (0, \delta), t > 0 \quad (1)$$

- initial condition:

$$T(x, 0) = T_0(x) \quad (2)$$

- boundary conditions:

$$T(x = \delta, t) = h(t) \quad (3)$$

$$-\lambda \frac{\partial T}{\partial x} \Big|_{x=\delta} = Q(t) \quad (4)$$

$$T(x = 0, t) = f(t) \quad (5)$$

where the temperature $f(t)$ is unknown.

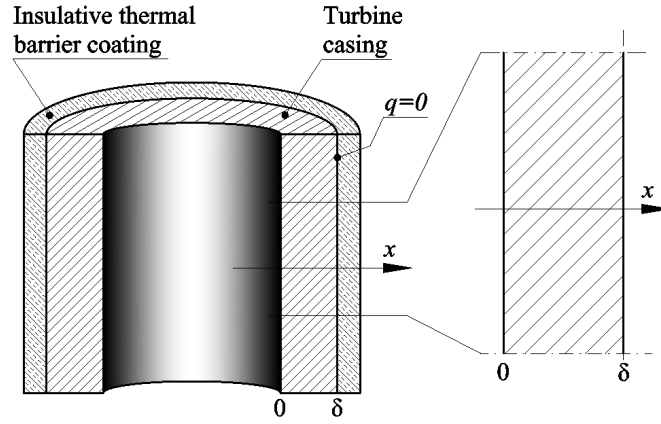

Fig. 1. Calculation area

In consideration of the boundary conditions (3) and (4) the problem formulated by [1-4] is Cauchy problem. For the next considerations the following non-dimensional variables are introduced:

$$T_{max} = \max_{x \in \langle 0,1 \rangle, t \geq 0} (T(x,t)), \quad \vartheta = \frac{T}{T_{max}}, \quad \xi = \frac{x}{\delta}, \quad \tau = \frac{\lambda}{\rho c} \cdot \frac{t}{\delta^2} \quad (6)$$

and now a non-dimensional formulation of the problem is the following:

- heat conduction equation

$$\frac{\partial \vartheta}{\partial \tau} = \frac{\partial^2 \vartheta}{\partial \xi^2}, \quad \xi \in (0,1), \quad \tau > 0 \quad (7)$$

- initial condition

$$\vartheta(\xi, 0) = \vartheta_0(\xi), \quad \xi \in \langle 0,1 \rangle \quad (8)$$

- boundary condition at surface $\xi = 1$

$$\vartheta(1, \tau) = h(\tau), \quad h = H \cdot T_{max}, \quad \tau > 0 \quad (9)$$

$$-\frac{\partial \vartheta(1, \tau)}{\partial \xi} = q(\tau), \quad q = \frac{\delta}{\lambda \cdot T_{max}} \cdot Q, \quad \tau > 0 \quad (10)$$

- unknown boundary condition at surface $\xi = 0$

$$\vartheta(0, \tau) = \chi(\tau), \quad \tau > 0. \quad (11)$$

In the consideration of linearity of equations (6-9) for their solution, the Laplace transformation will be used. Let

$$\mathcal{L}\vartheta(\xi, \tau) = \bar{\vartheta}(\xi, s) = \int_0^{\infty} \vartheta(\xi, \tau) \cdot e^{-s\tau} d\tau. \quad (12)$$

then the system of equations (6-9) is transformed to the form:

- heat conduction equation with initial condition:

$$\bar{\vartheta}(\xi, s) - s \cdot \vartheta(\xi, 0) = \frac{d^2 \bar{\vartheta}}{d\xi^2}, \quad \vartheta(\xi, 0) = \vartheta_0(\xi) \quad (13)$$

- boundary conditions at surface $\xi = 1$:

$$\bar{\vartheta}(1, s) = h(s) \quad (14)$$

$$\frac{-d\bar{\vartheta}(\xi, s)}{d\xi} = \bar{q}(s) \quad (15)$$

- unknown boundary condition at surface $\xi = 0$:

$$\bar{\vartheta}(0, s) = \bar{\chi}(s). \quad (16)$$

The idea of determination of unknown distribution (14) is based on the solution of direct problem, namely on solving equation (11) with condition (13) and (14) and on the next determination relation between unknown function $f(t)$ and measured temperature $h(t)$.

For simplicity it is assumed $\vartheta_0(\xi) = \vartheta_0 = const$, then the solution of direct problem has the form:

$$\begin{aligned} \bar{\vartheta}(\xi, s) = & \bar{\chi}(s) \cdot \frac{\cosh \sqrt{s}(1-\xi)}{\cosh \sqrt{s}} + \\ & + \bar{q}(s) \cdot \frac{\sinh \sqrt{s}\xi}{\sqrt{s} \cdot \cosh \sqrt{s}} + \frac{\vartheta_0}{s} \cdot \left(1 - \frac{\cosh \sqrt{s}(1-\xi)}{\cosh \sqrt{s}} \right). \end{aligned} \quad (17)$$

For $\xi = 1$:

$$\bar{\vartheta}(1, s) = \bar{\chi}(s) \cdot \frac{1}{\cosh \sqrt{s}} + \bar{q}(s) \frac{\tanh \sqrt{s}}{\sqrt{s}} + \frac{\vartheta_0}{s} \left(1 - \frac{1}{\cosh \sqrt{s}} \right). \quad (18)$$

The unknown function $\bar{\chi}(s)$ we will searched on the base of known distribution (9), namely

$$\bar{\vartheta}(1, s) = s \cdot \bar{\chi}(s) \cdot \frac{1}{s \cdot \cosh \sqrt{s}} + \bar{q}(s) \frac{\tanh \sqrt{s}}{\sqrt{s}} + \frac{\vartheta_0}{s} \left(1 - \frac{1}{\cosh \sqrt{s}} \right) = \bar{h}(s).$$

In this way we have Volterra integral equation of the second kind for determination of function $\chi(\tau)$ in the form

$$\begin{aligned} \mathcal{L}^{-1} [s \cdot \bar{\chi}(s)] * \mathcal{L}^{-1} \left[\frac{1}{s \cosh \sqrt{s}} \right] + \mathcal{L}^{-1} [s \bar{q}(s)] * \mathcal{L}^{-1} \left[\frac{\tanh \sqrt{s}}{s \sqrt{s}} \right] + \\ + \vartheta_0 \left\{ \eta(\tau) - \mathcal{L}^{-1} \left[\frac{1}{s \cosh \sqrt{s}} \right] \right\} = h(\tau). \end{aligned}$$

Therefore, the solution in the transformation region is

$$\begin{aligned} \bar{\vartheta}(\xi, s) = & s \cdot \bar{\chi}(s) \cdot \frac{\cosh \sqrt{s}(1-\xi)}{s \cdot \cosh \sqrt{s}} + \\ & + s \cdot \bar{q}(s) \cdot \frac{1}{s} \cdot \frac{\sinh \sqrt{s}\xi}{\sqrt{s} \cdot \cosh \sqrt{s}} + \vartheta_0 \left(\frac{1}{s} - \frac{1}{s \cdot \cosh \sqrt{s}} \right), \quad \xi \in \langle 0, 1 \rangle \end{aligned} \quad (19)$$

The poles of transform (19) are given by the equations

$$s = 0 \quad \text{and} \quad \cosh \sqrt{s} = 0 \quad (20)$$

Therefore, putting $\sqrt{s} = i \cdot \mu$ we obtain the following equation

$$\cosh \sqrt{s} = \cosh i \cdot \mu = \cos \mu = 0,$$

then

$$\mu_n = (2n-1) \cdot \frac{\pi}{2}, \quad n = 1, 2, \dots \quad (21)$$

In this way

$$\begin{aligned} & \mathcal{L}^{-1} \left[\frac{\cosh \sqrt{s}(1-\xi)}{s \cdot \cosh \sqrt{s}} \right] = \\ & = \underset{s=0}{res} \frac{\cosh \sqrt{s}(1-\xi)}{s \cdot \cosh \sqrt{s}} + \sum_{n=1}^{\infty} \underset{s=s_n}{res} \frac{\cosh \sqrt{s}(1-\xi)}{s \cdot \cosh \sqrt{s}} \cdot e^{s \cdot \tau} = \\ & = 1 + \sum_{n=1}^{\infty} \lim_{s=s_n} \frac{(s-s_n) \cdot \cosh \sqrt{s}(1-\xi)}{s \cdot \cosh \sqrt{s}} \cdot e^{s \tau} = \\ & = 1 - 2 \sum_{n=1}^{\infty} \frac{2 \cosh \mu_n(1-\xi)}{\mu_n \cdot \sin \mu_n} \cdot e^{-\mu_n^2 \cdot \tau} = \\ & = 1 - \frac{4}{\mu} \sum_{n=1}^{\infty} \frac{\sin \mu_n \xi}{2n-1} \cdot e^{-\mu_n^2 \cdot \tau} = \\ & \mathcal{L}^{-1} \left[\frac{1}{s} \cdot \frac{\sin \sqrt{s}\xi}{\sqrt{s} \cdot \cos 2} \right] = \xi - 2 \sum_{n=1}^{\infty} (-1)^{n-1} \cdot \frac{\sin \mu_n \xi}{\mu_n^2} \cdot e^{-\mu_n^2 \cdot \tau}, \end{aligned} \quad (22)$$

because

$$\mathcal{L}[q'(\tau)] = s \cdot q(s) - q(0) \quad \text{and} \quad \mathcal{L}^{-1}[sq(s)] = q'(\tau) + q_0 \cdot \delta(\tau),$$

then the inverse Laplace transformation is equal:

$$\begin{aligned}
\vartheta(\xi, \tau) &= \mathcal{L}^{-1} [\bar{\vartheta}(\xi, s)] = \vartheta_0 \left[1 - \frac{4}{\pi} \sum_{n=1}^{\infty} \frac{\sin(2n-1)\frac{\pi}{2}\xi}{2n-1} \cdot e^{-\mu_n^2 \cdot \tau} \right] + \\
&+ \mathcal{L}^{-1} [s \cdot \chi(s)] * \left[1 - \frac{4}{\pi} \sum_{n=1}^{\infty} \frac{\sin(2n-1)\frac{\pi}{2}\xi}{2n-1} \cdot e^{-\mu_n^2 \cdot \tau} \right] + \\
&+ \mathcal{L}^{-1} [sq(s)] * \left(\xi - \frac{8}{\pi^2} \sum_{n=1}^{\infty} (-1)^{n-1} \frac{\sin(2n-1)\frac{\pi}{2}\xi}{(2n-1)^2} \cdot e^{-\mu_n^2 \cdot \tau} \right) = \\
&= \vartheta_0 \left[1 - \frac{4}{\pi} \sum_{n=1}^{\infty} \frac{\sin(2n-1)\frac{\pi}{2}\xi}{2n-1} \cdot e^{-\mu_n^2 \cdot \tau} \right] + [\chi'(\tau) + \chi_0 \cdot \delta(\tau)] * \eta(\tau) - \\
&- 1 - \frac{4}{\pi} \sum_{n=1}^{\infty} \frac{\sin(2n-1)\frac{\pi}{2}\xi}{2n-1} \cdot e^{-\mu_n^2 \cdot \tau} \cdot \int_0^{\tau} [\chi'(p) + \chi_0 \cdot \delta(p)] \cdot e^{-\mu_n^2 \cdot p} \cdot dp + \\
&\quad + [q'(\tau) + q_0 \cdot \delta(\tau)] * \eta(\tau) \cdot \xi - \\
&- \frac{8}{\pi^2} \sum_{n=1}^{\infty} (-1)^{n-1} \frac{\sin(2n-1)\frac{\pi}{2}\xi}{(2n-1)^2} \cdot e^{-\mu_n^2 \cdot \tau} \cdot \int_0^{\tau} [q'(p) + q_0 \cdot \delta(p)] \cdot e^{-\mu_n^2 \cdot p} \cdot dp = \\
&= \vartheta_0 \left[1 - \frac{4}{\pi} \sum_{n=1}^{\infty} \frac{\sin(2n-1)\frac{\pi}{2}\xi}{2n-1} \cdot e^{-\mu_n^2 \cdot \tau} \right] + \chi(\tau) \cdot \left[1 - \frac{4}{\pi} \sum_{n=1}^{\infty} \frac{\sin(2n-1)\frac{\pi}{2}\xi}{2n-1} \right] + \\
&\quad + \pi \cdot \sum_{n=1}^{\infty} (2n-1) \cdot \sin(2n-1)\frac{\pi}{2}\xi \cdot e^{-\mu_n^2 \cdot \tau} \cdot \int_0^{\tau} \chi(p) \cdot e^{-\mu_n^2 \cdot p} \cdot dp + \\
&\quad + \sum_{n=1}^{\infty} \sin(2n-1)\frac{\pi}{2}\xi \cdot e^{-\mu_n^2 \cdot \tau} \cdot \int_0^{\tau} q(p) \cdot e^{-\mu_n^2 \cdot p} \cdot dp
\end{aligned} \tag{23}$$

For series in second bracketed in (23), if $\xi > 0$ then

$$\frac{4}{\pi} \sum_{n=1}^{\infty} \frac{\sin(2n-1)\frac{\pi}{2}\xi}{2n-1} = 1,$$

then the square bracket in (23) at function $\chi(\tau)$ is equal to zero for $\xi = 0$, $\vartheta(0, \tau) = \chi(\tau)$.

The next consideration is carried out for the case when $q(\tau) = 0$ and $\vartheta_0 = 0$, at that time the solution (23) can be written in the following form

$$\begin{aligned} \vartheta(\xi, \tau) &= \int_0^\tau \chi(p) \cdot 2 \sum_{n=1}^{\infty} \mu_n \cdot \sin \mu_n \xi \cdot e^{-\mu_n^2(\tau-p)} \cdot dp = \\ &= \int_0^\tau \chi(p) \cdot \psi(\xi, \tau, p) \cdot dp, \quad \xi \in (0, 1), \end{aligned} \tag{24}$$

where

$$\psi(\xi, \tau, p) = 2 \sum_{n=1}^{\infty} \mu_n \cdot \sin \mu_n \cdot e^{-\mu_n^2(\tau-p)}.$$

From condition (9) on the base (24) we obtained the following equation for determination of function $\chi(\tau)$

$$\vartheta(1, \tau) = \int_0^\tau \chi(p) \cdot \psi(1, \tau, p) \cdot dp = h(\tau) \tag{25}$$

or

$$\int_0^\tau \chi(p) \cdot \psi(1, \tau, p) \cdot dp = h(\tau) \tag{25a}$$

The equation is an integral equation of Volterra kind.

Solution of integral equation (25a)

Function $h(t)$ is the known temperature at the boundary $\xi = 1$ and in practice is known from the measurements in time points, with constant time steps $\tau_k = k \cdot \Delta\tau$, $k = 0, 1, 2, \dots$, then equation (25a) takes form:

$$\int_0^{\tau_k} \chi(p) \cdot \psi(1, \tau_k, p) \cdot dp = h(\tau_k) \quad \text{or} \quad \int_0^{\tau_k} \chi(p) \cdot \psi_k(1, p) \cdot dp = h(\tau_k) = h_k \tag{26}$$

Since

$$\int_0^{\tau_k} \chi(p) \cdot \psi_k(\xi, p) \cdot dp = \sum_{j=1}^k \int_{\tau_{j-1}}^{\tau_j} \chi(p) \cdot \psi_k(\xi, p) \cdot dp = \sum_{j=0}^k \chi_j \cdot \psi_{kj}(\xi) \tag{27}$$

equation (26) for succeeding time while instants takes the form:

$$\left\{ \begin{array}{l} k = 1 \quad : \quad \chi_0 \cdot \psi_{10} + \chi_1 \cdot \psi_{11} = h_1 \\ k = 2 \quad : \quad \chi_0 \cdot \psi_{20} + \chi_1 \cdot \psi_{21} + \chi_2 \cdot \psi_{22} = h_2 \\ k = 3 \quad : \quad \chi_0 \cdot \psi_{30} + \chi_1 \cdot \psi_{31} + \chi_2 \cdot \psi_{32} + \chi_3 \cdot \psi_{33} = h_3 \\ \dots \end{array} \right. \tag{28}$$

Then for $\chi_0 = 0$ the system of equation (28) has the following solution

$$\chi_1 = (h_1/\psi_{11}) \quad \chi_k = \left(h_k - \sum_{j=1}^{k-1} \psi_{kj}(\xi = 1) \cdot \varphi_j \right) / \psi_{kk}, \quad k \geq 2 \quad (29)$$

Let's determine the elements ψ_{kj} of the matrix $[\psi]$. These elements ψ_{kj} are essentially dependent from the way of integration of function $\chi(p)$; the simplest way of integration in (27) can be expressed as

$$\begin{aligned} & \int_0^{\tau_k} \chi(p) \cdot \psi_k(\xi, p) \cdot dp = \sum_{j=1}^k \int_{\tau_{j-1}}^{\tau_j} \chi(p) \cdot \psi_k(\xi, p) \cdot dp = \\ & = \sum_{j=1}^k \int_{\tau_{j-1}}^{\tau_j} [\Theta \cdot \chi_{j-1} + (1 - \Theta) \cdot \chi_j] \cdot \psi_k(\xi, p) \cdot dp = \\ & = \sum_{j=1}^k [\Theta \cdot \chi_{j-1} \cdot r_j + (1 - \Theta) \cdot \chi_j \cdot r_j] = \Theta \cdot \chi_0 \cdot r_{k1} + \\ & + \sum_{j=1}^k \chi_j [\Theta \cdot r_{kj+1} + (1 - \Theta) \cdot r_{kj}] + (1 - \Theta) \chi_k \cdot r_{kk} = \sum_{j=0}^k \chi_j \psi_{kj} \\ & r_{kj} = \int_{\tau_{j-1}}^{\tau_j} \psi_k(\xi, p) \cdot dp \end{aligned} \quad (30)$$

$$\begin{aligned} \chi_{k0} &= \Theta \cdot r_{k1}, & \chi_{kj} &= \Theta \cdot r_{kj+1} + (1 - \Theta) r_{kj} \\ j &= 1, \dots, k-1, & \chi_{kk} &= (1 - \Theta) r_{kk}, \quad \Theta \in (0, 1) \end{aligned}$$

The system of equation (28) can be written in the matrix form

$$[\psi] \{\chi\} = \{h\}, \quad \dim[\psi] = M \times M, \quad \dim\{h\} = M \quad (31)$$

Since

$$\psi(\xi, \tau, p) = 2 \sum_{n=1}^{\infty} \mu_n \cdot \sin \mu_n \xi \cdot e^{-\mu_n^2(\tau-p)}$$

then for we have $\tau_k = k \cdot \Delta\tau$

$$\begin{aligned} r_{kj} &= \int_{\tau_{j-1}}^{\tau_j} \psi(\xi, \tau, p) \cdot dp = 2 \sum_{n=1}^{\infty} \mu_n \cdot \sin \mu_n \xi \cdot \int_{\tau_{j-1}}^{\tau_j} e^{-\mu_n^2(\tau-p)} \cdot dp = \\ & = 2 \sum_{n=1}^{\infty} \frac{\sin \mu_n \xi}{\mu_n} \cdot \left(e^{-\mu_n^2(\tau_k - \tau_j)} - e^{-\mu_n^2(\tau_k - \tau_{j-1})} \right) = \\ & = 2 \sum_{n=1}^{\infty} \frac{\sin \mu_n \xi}{\mu_n} \cdot \left(e^{-\mu_n^2 \Delta\tau(k-j)} - e^{-\mu_n^2 \Delta\tau(k-j+1)} \right) \end{aligned} \quad (32)$$

It should be noted that $r_{kj} = r_{k+1,j+1}$. Then $\psi_{kj} = \psi_{k+1,j+1}$. This property allows to reduce the calculation time of the elements of matrix $[\psi]$.

3 Numerical Calculations

In order to test the solution of integral equation (26) we will compare the numerical solution with the analytical solution. The analytical solution to equation (7) with the initial condition $\vartheta(\xi, 0) = 0$ and the following boundary conditions

$$\vartheta(\xi = 0, \tau) = T_b \cdot (1 - e^{-\beta\tau}), \quad -\frac{\partial\vartheta(\xi = 1, \tau)}{\partial\xi} = Bi \cdot \vartheta(\xi = 1, \tau) \quad (33)$$

has the form

$$\begin{aligned} \vartheta(\xi, \tau) &= T_b \cdot \left(1 - \frac{Bi}{Bi+1} \cdot \xi\right) (1 - e^{-\beta\tau}) + \\ &+ 2T_b \cdot \beta \cdot e^{-\beta\tau} \cdot \sum_{n=1}^{\infty} w_n(\xi) \cdot \frac{1}{p_n^2 - \beta} - \\ &- 2T_b \cdot \beta \cdot \sum_{n=1}^{\infty} w_n(\xi) - \frac{1}{p_n^2 - \beta} \cdot e^{-p_n^2\tau}, \\ w_n(\xi) &= -\frac{\sin p_n \xi}{p_n} \cdot \left(1 - \frac{Bi}{Bi^2 + Bi + p_n^2}\right), \end{aligned} \quad (34)$$

where the numbers p_n are the following roots of equation

$$\tan p_n = -\frac{p_n}{Bi}, \quad n = 1, 2, \dots, \quad \text{and } p_n = \frac{\pi}{2} (2n - 1) \text{ as } Bi \rightarrow 0,$$

and

$$\lim_{\tau \rightarrow \infty} \vartheta(\xi, \tau) = T_b \cdot \left(1 - \frac{Bi}{Bi+1} \cdot \xi\right)$$

Solution (34) is used for the determination of functions $h(t)$ and $q(t)$ given by formulas (9) and (10).

System (28) is numerically unstable and finding a solution to (31) for relatively low values M leads to solving a system of equation of order $M - 1$. Therefore, a regularization is needed. The oscillations of the vector $\{\chi\}$ are appeared at the end of the interval $\langle 0, M \cdot \Delta\tau \rangle$, see Fig.2.

Regularization of solution of system of equations (31)

At each segment $\langle \tau_{j-1}, \tau_j \rangle$, $j = 1, \dots, M$ the function $\chi(\tau)$ in (30) is approximated by the constant $\Theta = \Theta_{j-1} + \Theta_j \cdot (1 - \Theta)$, $0 < \Theta < 1$, and therefore it is not differentiable between the segments and has a jump of the first derivative.

Leading the first parabola $\chi_{j-2,j-1,1}$ through the following points (τ_{j-2}, χ_{j-2}) , (τ_{j-1}, χ_{j-1}) , (τ_j, χ_j) and the second parabola $\chi_{j-1,j,j+1}$ through the points (τ_{j-1}, χ_{j-1}) , (τ_j, χ_j) , (τ_{j+1}, χ_{j+1}) we require that the difference between the first derivative in common points of the both parabolas must be equal to zero,

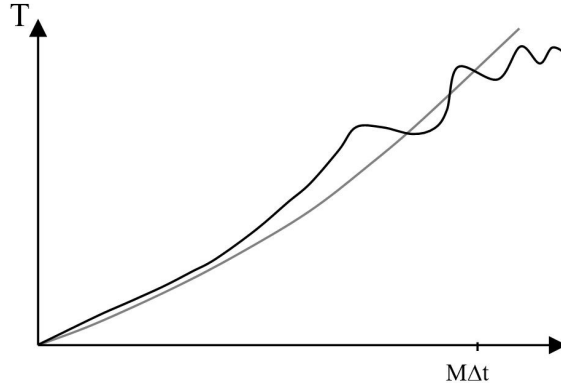

Fig. 2. Oscillations of solution of system of equations (31)

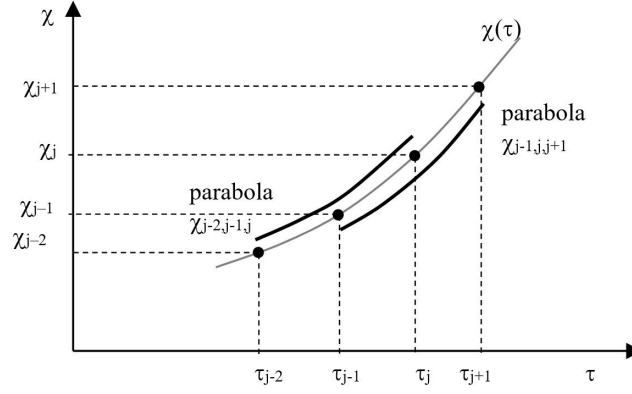

Fig. 3. Idea of parabolic regularization of solution $\chi(\tau)$

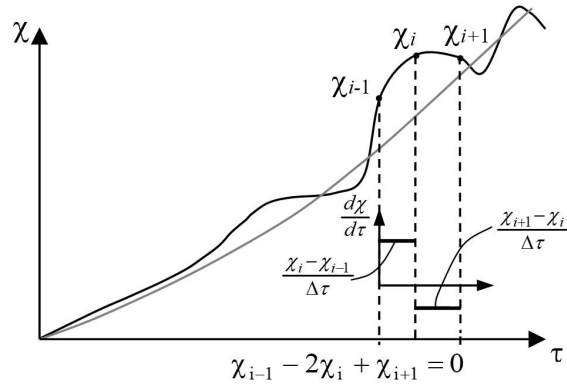

Fig. 4. Idea of linear regularization of solution $\chi(\tau)$

what in the case uniform net τ_{j-1} and τ_j $\tau_k - \tau_{k-1} = h$, $k = 1, 2, \dots, M$ leads to the equation on the interval $\langle \tau_{j-2}, \tau_{j+1} \rangle$

$$\chi_{j-2} - 3\chi_{j-1} + 3\chi_j - \chi_{j+1} = 0, \quad j = 2, \dots, M-2. \quad (35)$$

In the case of linear regularization, as shown in Fig. 4, the conditions leading to the elimination of a jump of the first derivative are

$$\chi_{j-1} - 2\chi_j + \chi_{j+1} = 0, \quad j = 1, 2, \dots, M-1. \quad (36)$$

The dimension of matrix $[\psi]$ is $\dim[\psi] = (M+1) \times (M+1)$, whereas for not large values M , $\text{rank}[\psi] = M$, then it is sufficient to add condition (35) for $j = M-1$ to the system of equation (28). Let us consider a more general case, namely, add condition (35) or (36) to system (28) with the internal knot number $M-3$. The system of equation is as follows

$$\begin{bmatrix} [\psi] \\ [w] \end{bmatrix} \{\chi\} = \begin{Bmatrix} \{h\} \\ \{0\} \end{Bmatrix}, \quad \dim[\psi] = (M+1) \times (M+1), \quad (37)$$

where the matrix $[w]$ in accordance with condition (35) has the form

$$[w] = \begin{bmatrix} 1 & -3 & 3 & -1 & \dots & 0 \\ \dots & \dots & \dots & \dots & \dots & \dots \\ 0 & \dots & 1 & -3 & 3 & -1 \end{bmatrix}, \quad \dim[w] = (M-3) \times (M+1). \quad (38)$$

For condition (36) we have the following matrix

$$[w] = \begin{bmatrix} 1 & -2 & 1 & \dots & 0 \\ \dots & \dots & \dots & \dots & \dots \\ 0 & \dots & 1 & -2 & 1 \end{bmatrix}, \quad \dim[w] = (M-1) \times (M+1). \quad (39)$$

The solution of over-determined system of equations (37) can be obtained by minimization of the functional

$$J(\{\chi\}) = \|[\psi] \{\chi\} - \{h\}\|^2 + \alpha^2 \|[w] \{\chi\}\|^2. \quad (40)$$

If an exact solution $\{\chi^0\}$ is known, then minimization of functional

$$J(\{\chi\}, \{\chi^0\}) = \|[\psi] \{\chi\} - \{h\}\|^2 + \alpha^2 \|[w] (\{\chi\} - \{\chi^0\})\|^2 \quad (41)$$

is equivalent to solving the system of equations for each value of the parameter α which leads to the system of equations

$$\begin{bmatrix} [\chi] \\ \alpha [w] \end{bmatrix} \{\chi\} = \begin{Bmatrix} \{h\} \\ \alpha [w] \{\chi^0\} \end{Bmatrix} = \begin{Bmatrix} \{h\} \\ \{0\} \end{Bmatrix} + \begin{bmatrix} [0] \\ \alpha_{reg} [w] \end{bmatrix} \{\chi^0\} \quad (42)$$

or

$$\begin{aligned} [\psi_\alpha] \{\chi\} &= \{F_1\} + [P_\alpha] \{\chi^0\}, \\ \dim[\psi_\alpha] &= \dim[P_\alpha] = (M+1 + M-2) \times (M+1). \end{aligned} \quad (43)$$

Then

$$\begin{aligned} \{\chi\} &= [\psi_\alpha]^+ \cdot \{F\} + [\psi_\alpha]^+ \cdot [P_\alpha] \{\chi^0\} = \{G_\alpha\} + [Q_\alpha] \{\chi^0\} \\ \dim [Q_\alpha] &= (M+1) \times (M+1) \end{aligned} \quad (44)$$

In general case the vector $\{\chi^0\}$ is unknown, then creating the iteration process

$$\{\chi^{n+1}\} = \{G_\alpha\} + [Q_\alpha] \{\chi^n\}, \quad n = 0, 1, 2, \dots, \quad (45)$$

we have

$$\{\chi^{n+1}\} = \sum_{j=0}^n [Q_\alpha]^j \cdot \{G_\alpha\} + [Q_\alpha]^{n+1} \{\chi^0\} \quad (46)$$

If the spectral radius ρ_s of the matrix $[Q_\alpha]$, $\rho_s([Q_\alpha]) < 1$, then Neumann series in (46) is convergent.

In the case considered in the paper the spectral radius $\rho_s = 1$.

For the determination of the parameter α a modification of L-curve [8] is used. As a regularization matrix $[w]$ the matrix (36) resulting from condition (36) is taken. A classic L-curve is presented in Fig. 5, which corresponds to the matrix $[w] = [I]$. For the matrix $[w]$ determined according to (39), this curve has the shape given in Fig. 6. To obtain an explicit relationship with respect to regularization the parameter α the function

$$\frac{\|[w] \{\chi\}\|}{\|[\psi] \{\chi\} - \{h\}\|} = f(\alpha) \quad (47)$$

is introduced (see Fig. 7). The corner points in Figures 6 and 7 correspond the same value of parameter α . This value of parameter α corresponds to the minimum of the non-dimensional function

$$\frac{\|[\alpha \cdot w] \{\chi\}\|}{\max(\|[\alpha \cdot w] \{\chi\} - \{h\}\|)} = f\left(\frac{\|[\psi] \{\chi\} - \{h\}\|}{\max(\|[\psi] \{\chi\} - \{h\}\|)}\right), \quad (48)$$

see Fig. 8. The indicated point of extreme on curve b) (48) correspond the inflexion of curves

$$\frac{\|\{\chi\}\|}{\max(\|\{\chi\}\|)} = f\left(\frac{\|[\psi] \{\chi\} - \{h\}\|}{\max(\|[\psi] \{\chi\} - \{h\}\|)}\right), \quad (49)$$

and

$$\frac{\alpha}{\alpha_{max}} = f\left(\frac{\|[\psi] \{\chi\} - \{h\}\|}{\max(\|[\psi] \{\chi\} - \{h\}\|)}\right). \quad (50)$$

For optimal values of regularization parameter α the inverse determination of temperature at the points $\xi = 0$ and $\xi = 1$ and a comparison with exact data were done. The obtained results confirm the appropriate choice of the curve (48). This curve can be modified for the obtained relationship

$$\frac{\|[\alpha \cdot w] \{\chi\}\|}{\max(\|[\alpha \cdot w] \{\chi\} - \{h\}\|)} \left(\max \frac{\|[\alpha \cdot w] \{\chi\}\|}{\|[\psi] \{\chi\} - \{h\}\|}\right)^{-1} = f(\alpha), \quad (51)$$

which is presented in Fig. 9. Noisy data were at level 10%. Conditional number was calculated as follows

$$\text{condn}([\psi]) = \frac{\sigma_{max}([\psi])}{\sigma_{min}([\psi])}, \sigma_{min} > 0 \tag{52}$$

where in general σ is the singular value of the matrix $[\psi]$.

The solution of inverse problem for different values of regularization parameter α are given in Fig. 10 and 11. The course of temperature show the comparison of temperature distribution over the time at point $\xi = 0.0$ and $\xi = 1.0$ respectively for exact and noisy data and two values of regularization parameters α .

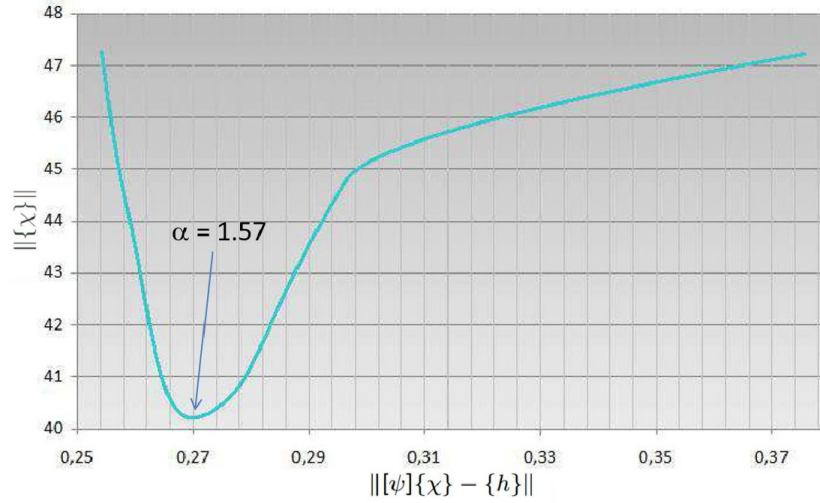

Fig. 5. Classic L - curve (Hansen[8]), in coordinates $(\|[\psi]\{\chi\} - \{h\}\|, \|\{\chi\}\|)$

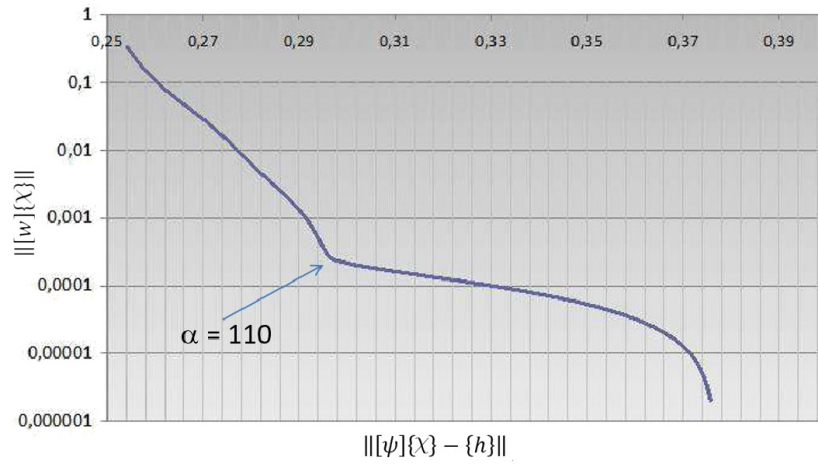

Fig. 6. L - curve in coordinates $(\|[\psi]\{x\} - \{h\}\|, \| [w]\{x}\|)$

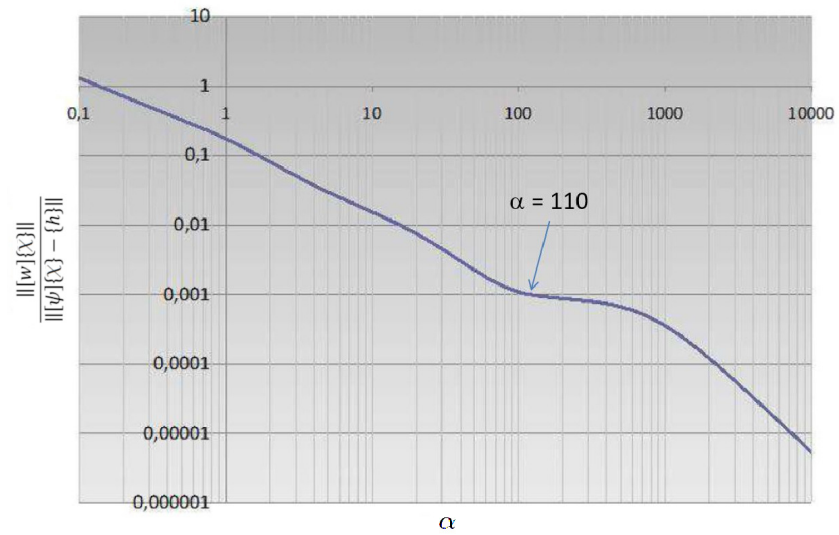

Fig. 7. L - curve in coordinates $(\alpha, \frac{\| [w]\{x}\|}{\| [\psi]\{x\} - \{h}\|})$

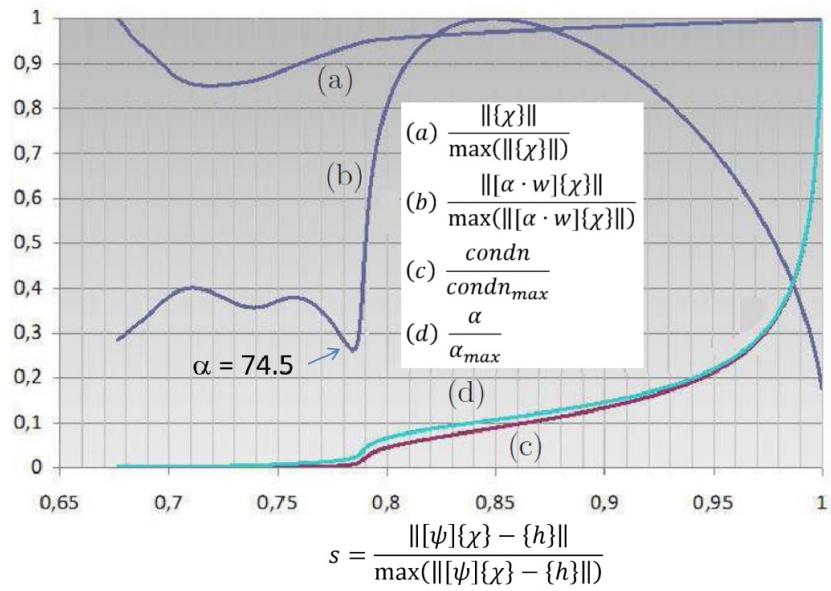

Fig. 8. Dimensionless distributions of: $\|\{\chi\}\| / \max(\|\{\chi\}\|)$, α/α_{max} , $\|\{\alpha \cdot w\}\{\chi\}\| / \max(\|\{\alpha \cdot w\}\{\chi\}\|)$, $condn/condn_{max}$, as function of dimensionless values

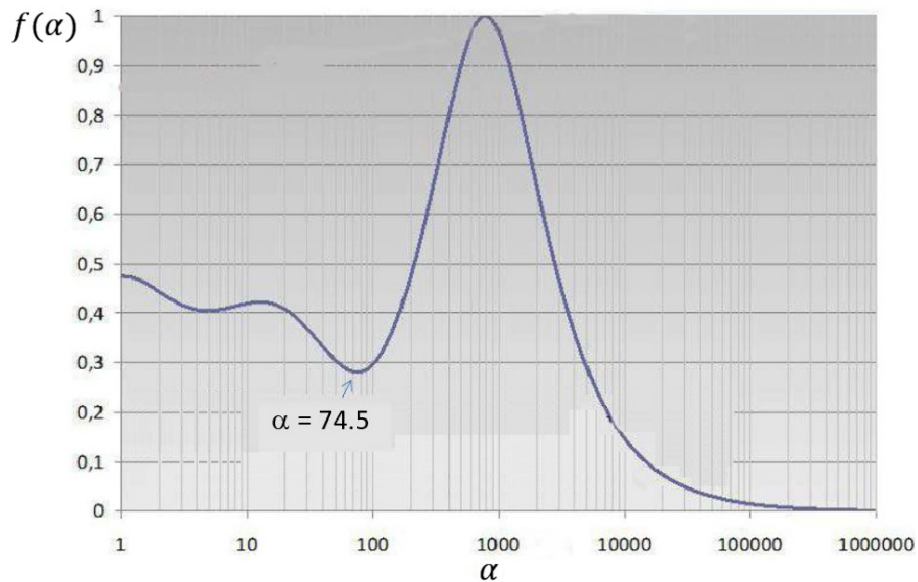

Fig. 9. L-curve in coordinates given by (52) after 200 time steps

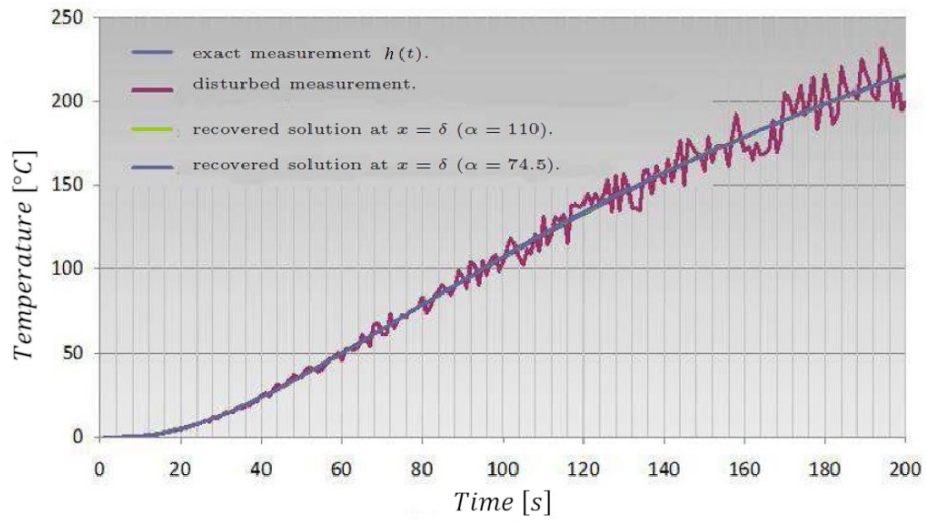

Fig. 10. Comparison of solution of inverse problem with given data, boundary $\xi = 1.0$, for different values of regularization parameter α

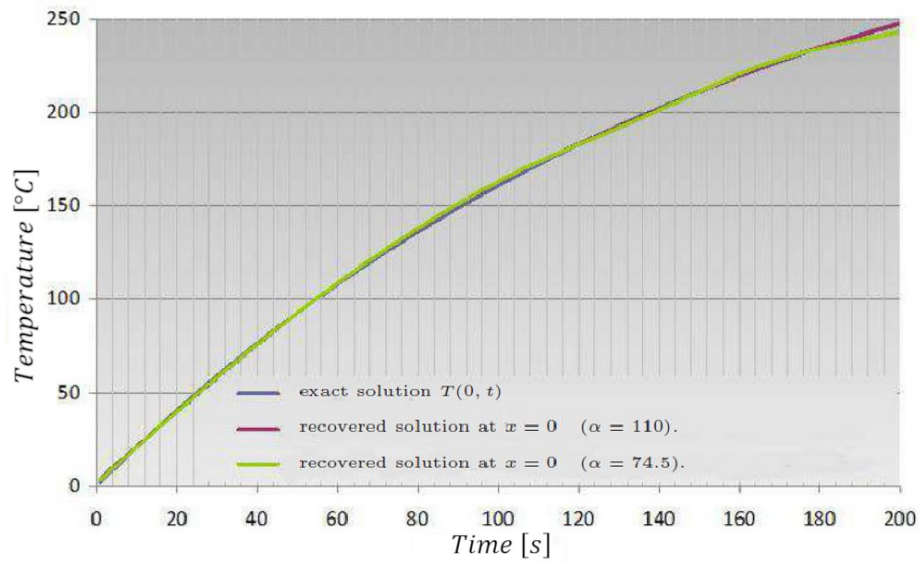

Fig. 11. Comparison of solution of inverse problem with exact data, boundary $\xi = 0.0$, for different values of regularization parameter α

4 Final Remarks

The consideration given in the paper permits the replacement of the classic L-curve (Hanson [8]) by its modified version, L-w-curve is taken in coordinates $(\|[\psi] \{\chi\} - \{h\}\|, \| [w] \{\chi\} \|)$, where the matrix of regularization $[w]$ is taken into account (for $[w] = [I]$, the curve L-w is the same as L-curve). The optimal point for L-w-curve is very near to the extremal point on L- αw -curve in coordinates $(\|[\psi] \{\chi\} - \{h\}\|, \|[\alpha w] \{\chi\}\|)$ (see Fig. 9). The L-R-curve is the function of parameter α and allows you to track changes of $\frac{\|[\alpha w] \{\chi\}\|}{\|[\psi] \{\chi\} - \{h\}\|}$ as the function of parameter α . The optimal point on L- αw -curve corresponds to the point of inflexion of function $\| \{\chi\} \|$ and condition number *condn* of function $\|[\psi] \{\chi\} - \{h\}\|$, Fig. 8.

The way of regularization (39) tested in the paper allows us to obtain good solution of the Cauchy problem even if the measurements error is 10.0%. This is due to fact that the chosen way of regularization to achieve the smoothness of solution is close to physical distribution.

Acknowledgement: The paper was carried out in the frame of grant N0. 4917/B/T02/2010/39 financed by the Ministry of Higher Education.

References

1. De Lillo, S., et al: A Cauchy problem in nonlinear heat conduction. Journal of Physics A: General Physics **39**(23), 7299–7303 (2006)
2. Marin, L., LesnicDe, D.: The method of fundamental solutions for the Cauchy problem associated with two-dimensional Helmholtz-type equations. Computers & Structures **83**(4–5), (2005)
3. Elden, L.: Numerical solution of the sideways heat equation by difference approximation in time. Inverse Problems **11**(913), (1995)
4. Fu, C.L.: Simplified Tikhonov and Fourier regularization methods on a general sideways parabolic equation, Journal of Computational and Applied Mathematics **167**(2), 449–63 (2004)
5. Shidfar, A., Pourgholi, R.: Numerical approximation of solution of an inverse heat conduction problem based on Legendre polynomials, Applied Mathematics and Computation **175**(2), 1366–374, (2006).
6. Reginska, T., Eldén, L., Solving the sideways heat equation by a wavelet Galerkin method, Inverse Problems **13** 1093, (1997).
7. Haò, D.N.: A Noncharacteristic Cauchy Problem for Linear Parabolic Equations I: Solvability, Mathematische Nachrichten **171**(1), 177—206, (1995).
8. Hansen C., O’Leary, D. P.: The use of the L-curve in the regularization of discrete ill-posed problems. SIAM J. Sci. Compt. **14**(6), 1487–503, (1993).