



## Using VIVE Tracker to Detect the Trajectory of Mobile Robots

---

Yong Wang, Peng Tian, Yu Zhou, Mao Mao Zhu, Qing Chen  
and Chang Zhang

EasyChair preprints are intended for rapid dissemination of research results and are integrated with the rest of EasyChair.

September 20, 2021

# Using VIVE Tracker to Detect the Trajectory of Mobile Robots

Yong Wang\*<sup>a</sup>, Peng Tian<sup>bc</sup>, Yu Zhou<sup>a</sup>, M. Mao Zhu<sup>a</sup>, Qing Chen<sup>a</sup>, Chang Zhang<sup>a</sup>

<sup>a</sup> Xuzhou Inspection and Testing Center, No12 Shangju Road, Xu Zhou, Jiang Su, China 221111; <sup>b</sup> China University of Mining, No1 Daxue Road, Xuzhou, Jiangsu, China 221116; <sup>c</sup> Xuzhou Institute of Surveying and Mapping, No1 Xinan Road, Xuzhou, Jiangsu, China 221018

## ABSTRACT

The detection of mobile robot performance often requires costly and high-precision trajectory tracking equipment, which is often difficult for testing laboratories to afford. Therefore, it becomes a difficult problem to find the equipment that is cheap and can meet the detection requirements. HTC's Vive Tracker, as an inexpensive virtual reality (VR) accessory, provides good measurement accuracy. In this study, the Vive Tracker is used for the purpose of mobile robot performance detection, mainly focusing on the ability of the device to capture and analyze the mobile robot's movement trajectory. Through the test and analysis of Vive Tracker, it is verified that Vive Tracker can meet the accuracy requirements of mobile robot detection, and can well capture the mobile robot's movement trajectory and be used for mobile robot performance analysis.

**Key words:** mobile robot, vive tracker, trajectory, accuracy, detection

## INTRODUCTION

The detection of mobile robot's mobility (performance) often requires high-precision trajectory tracking equipment<sup>[1]</sup>. Low-cost indoor positioning technologies, such as WIFI positioning and Bluetooth positioning, have a precision of 1-5 meters<sup>[2]</sup>, while the slightly higher cost Ultra Wide Band(UWB) positioning can reach 10cm(decimeter level). Yet for performance test of mobile robots tend to require positioning precision of the test system to achieve millimeter level<sup>[3]</sup>, obviously the positioning technology can't meet the needs of the robot to test, but if you want to reach higher than millimeter positioning measurement, you need to use such as laser tracker (Leica/ Faro/API)<sup>[4]</sup>, measurement accuracy can reach micron grade, or motion capture instrument (OptitRack, Qualisys, Vicon, etc.)<sup>[5]</sup>, which can measure up to 0.1 mm. However, such detection equipment is often expensive, ranging from hundreds of thousands of dollars (laser tracker) to hundreds of thousands of dollars (motion capture equipment), which is often difficult for the average researcher to afford. With the development of VR technology and products, in order to allow the operator to experience a good sense of presence, VR equipment must be able to achieve millimeter level continuous positioning, so a series of derived millimeter level positioning technology to fill the gap, and the price is less than \$500. Different from the products of other companies. HTC has launched Vive series VR products based on Lighting House technology. In addition to providing Head Mounted Display (HMD) headsets and gamepad commonly used in games, they also provide Tracker components with unique styling, such as Tracker2.0 version in Figure 1, which is used to extend other simulation equipment, such as laser gun. The shape and volume of the Tracker unit are designed to be very easy to install and also access motion data from the built-in inertial measurement unit (IMU) to maintain a smooth and continuous trajectory, according to the literature<sup>[6]</sup>, the average deviation of Tracker's positioning accuracy in the case of HTC Vive dual base stations is about 3.5mm. Because these characteristics and accuracy of Tracker just meet the needs of current mobile robot testing, HTC Vive is used in this paper.

Tracker, as a robot test equipment, is studied on some basic elements, such as the test accuracy, calibration method and test index of Tracker. This article will read the VIVE Tracker's spatial position and posture data in real time through ROS and draw the robot's walking trajectory for subsequent analysis.



a. Appearance

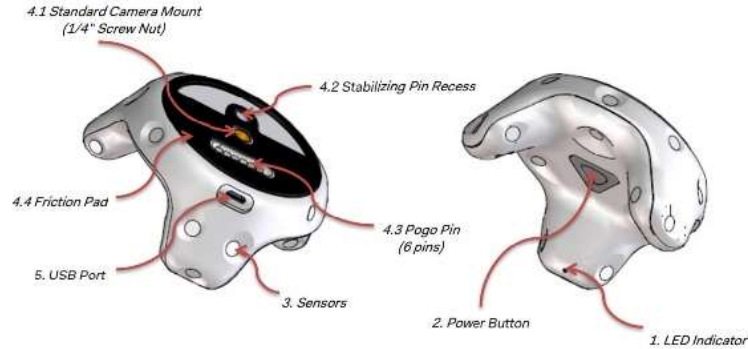

Figure: Main features

b. Structure

Figure 1. HTC Vive Tracker 2.0

**POSITIONING PRINCIPLE OF THE TRACKER**

Tracker's location relies on a technique called Lighthouse<sup>[7]</sup>, which relies on the Base Station for location. Lighthouse consists of two base stations: each base station has an infrared LED array and two rotating infrared laser transmitters with axes perpendicular to each other, as shown in Figure 2a. The rotation speed is 10ms per turn. The working status of the base station is as follows :20ms is a cycle. At the beginning of the cycle, the infrared LED flashes. Within 10ms, the rotating laser of the X-axis sweeps the whole space, while the Y-axis does not emit light. In the next 10ms, a rotating laser on the Y-axis sweeps the entire space, while the X-axis does not emit light. Valve has a number of photosensitive sensors installed on the head display and controller. The working status of the base station is as follows :20ms is a cycle. At the beginning of the cycle, the infrared LED flashes. Within 10ms, the rotating laser of the X-axis sweeps the whole space, while the Y-axis does not emit light. In the next 10ms, a rotating laser on the Y-axis sweeps the entire space, while the X-axis does not emit light. Valve has a number of photosensitive sensors installed on the head display and controller. In the

base station will be LED flash sync signal, then the photosensitive sensor can measure the X axis and Y axis laser time of arrival in sensor respectively This time is just the X axis and Y axis laser turn to this particular, the Angle of the light sensors, so the sensor relative to the base station of the X axis and Y axis Angle would be known; The positions of the photosensitive sensors distributed on the head display and the controller are also known, so the position and motion trajectory of the head display can be calculated by the position difference of each sensor, as shown in Figure 2b.



a.

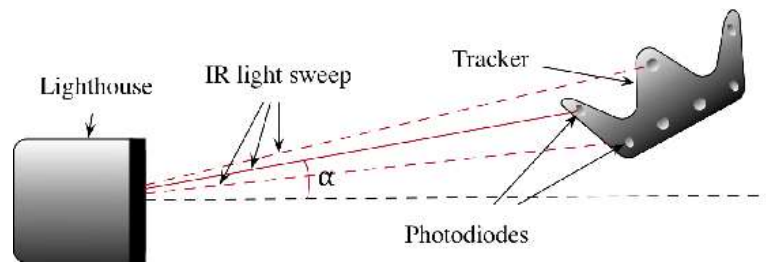

b.

Figure 2. Positioning principle of Lighthouse technology

## INSTALLATION OF THE TRACKER DURING THE TEST OF THE ROBOT

### 3.1 SWEEPING ROBOT

The sweeping robot used in the experiment uses omni vision navigation sensor, with a field of view Angle of 166 degrees, which can simulate the neural network algorithm to achieve visual dynamic mapping<sup>[8]</sup>. At the same time, with 50 times/second path calculation, it can maintain dynamic survey while traveling. After the robot builds the drawing for the first time, it will have a long-term memory and will not go into the same room repeatedly when cleaning. It will build the drawing in real time through the APP and can know the cleaning situation at any time on the mobile phone<sup>[9]</sup>.



Figure 3. The sweeping robot in test

### 3.2 CHOICE OF INSTALLATION LOCATION

A Tracker is used to test the trajectory of the robot by attaching it to the body of the robot. Before installation, it is necessary to know the coordinate system of Tracker and robot, so that the installation relationship can be determined. The coordinate system of Tracker is shown in Figure 4. The red axis is the X axis, the green axis is the Y axis, and the blue axis is the Z axis. Similarly, the color of the robot coordinate system is consistent with that of Tracker.

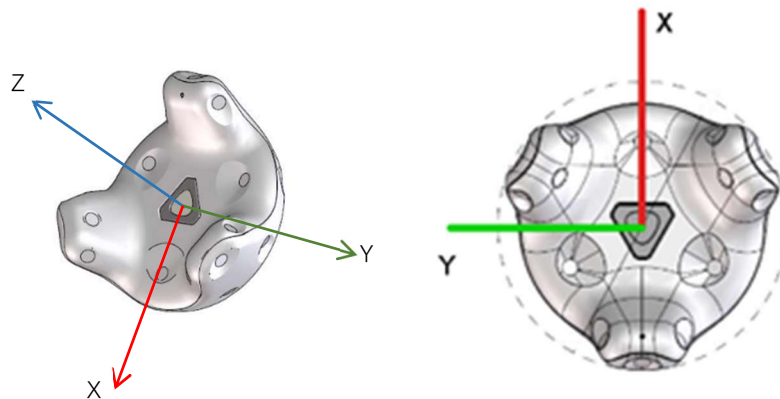

Figure 4. Vive Tracker's coordinate system

Based on our testing experience, the installation of sensors can follow the following principles:

1. Tracker should be installed as far as possible at the geometric center of the robot plane projection. If the central position may affect the use of the sensor, such as blocking the vision sensor or laser scanning, the Tracker should be installed on the center line of the robot plane projection as far as possible;
2. The coordinate system of Tracker should be as consistent as possible with the coordinate system of the robot, that is, the XYZ axis should be in the same direction;
3. Try to keep the Tracker level.

In short, make the coordinate transformation relationship between Tracker and robot as simple as possible, so as to simplify the transformation between Tracker and robot coordinate system. For this test, we used 3M double-sided tape to stick to

the central position of the robot, as shown in Figure 5. During installation, the X and Y of the robot and Tracker coordinates are parallel, while their Z axes coincide. Since the test of the sweeping robot is on the horizontal plane, that is, the displacement trajectory of the XY plane is tested, the installation method in the experiment makes the offset between the robot coordinate system and the Tracker coordinate system (0,0). For some robots with laser scanning, because the scanning head is usually located in front of the robot and is raised, the Tracker can only be mounted on top of the raised laser scanning head, with an offset equal to the offset between the laser scanning head and the center of the robot.

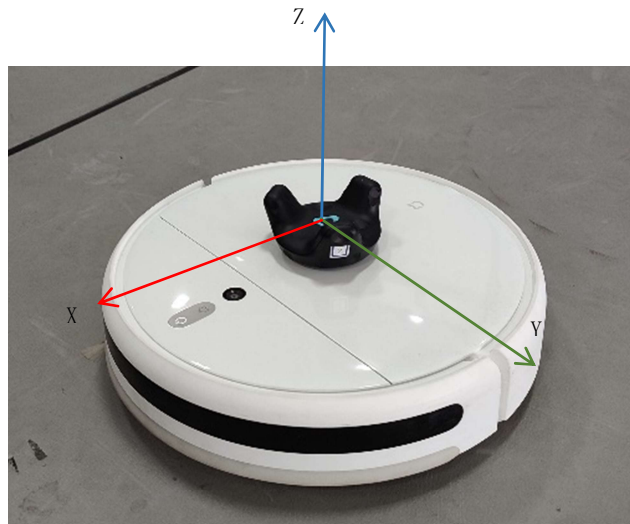

Figure 5. Selection of the location of the robot to install the Tracker

## TESTING PROCESS

### 4.1 TEST SITE LAYOUT

In order to test the walking track of the robot, EPP building blocks were used to build the test site, as shown in FIG. 6. The ground area of the test space is 4.5\*4.05 square meters. The two minaret base stations of Vive are respectively placed in the middle of the short side wall of the test space. The direction of the two minaret base stations is adjusted so that their scanning range can cover the whole test space. The charging station of the robot is placed on one side of the wall of the test space, and the robot is placed in the starting position.

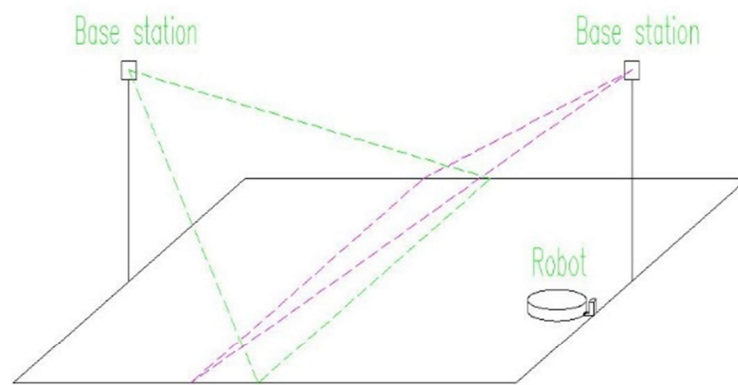
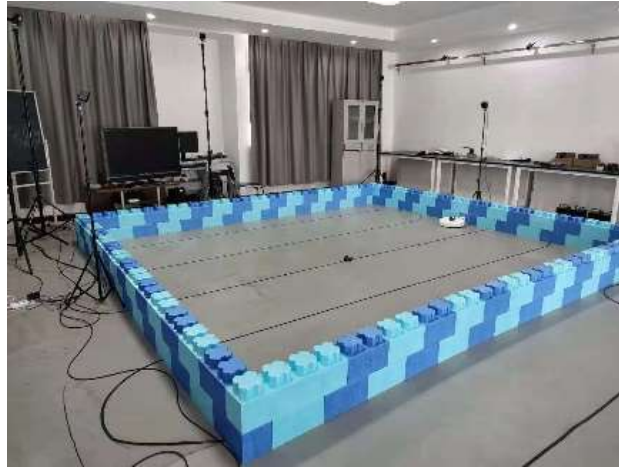

Figure 6. Mobile robot test site built with EPP building blocks

#### 4.2 TEST SYSTEM CONSTRUCTION

The structure of the system is shown in Figure 7. The whole system software is installed on a PC with Ubuntu as the operating system. The PC is connected to two Dongles through USB interface, and the two Dongles are wirelessly paired to connect to two Tracker respectively, while the two positioning base stations are connected to the PC through the wireless link with Tracker.

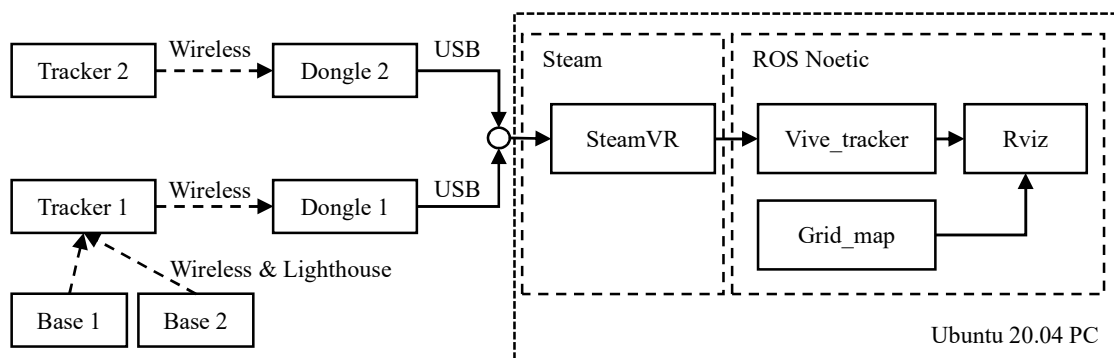

Figure 7. ROS Noetic Node publishes pose and map data from HTC Vive Tracker Ubuntu 20.04.

### **4.3INSTALL AND CONFIGURE THE RUNNING ENVIRONMENT**

For this study, SteamVR<sup>[10]</sup> and the Robot Operating system (ROS) were used to build the environment for the software to run, as shown in Figure 6. SteamVR is a module of Steam<sup>[11]</sup> software that connects to virtual reality hardware, such as HMD, gamepads, etc. In our project, it is used to connect and drive the Tracker. In this project, we use the VERSION of Steam API v020, SteamVR 1.19.2. In the project, ROS is used for coordinate system transformation, visualization of robot walking path, map display, etc. ROS adopts Noetic version<sup>[12]</sup>, which is the last version of ROS 1.0 and supports Python 3<sup>[13]</sup>. At the same time, it is also the long Term maintenance version (LTS version). In order to better adapt to the current software and hardware environment, we choose this version of ROS. In contrast, ROS Noetic runs Ubuntu 20.04 LTS<sup>[14]</sup>.

### **4.4TEST SYSTEM SOFTWARE DEBUGGING**

The software running environment is configured, but the data flow is not connected. The Steam VR Trackers data needs to be passed to the CORRESPONDING ROS module for interpretation, distribution, storage and mapping. In this case, we used the Vive tracker program of Moon-wreckers on Github and the setting method of Steam VR<sup>[15]</sup>, it can publish the location information of the Tracker obtained by Steam VR into the theme in ROS, and then visualize the robot's running trajectory through 3D visualization platform--Rviz. Since the experiment in this paper only requires the HTC Vive's tower base Tracker 2.0 locator and the wireless USB dongle, there is no need to connect to the VR headset. moon-wreckers also mentioned the Steam VR module configuration, so that the test system does not require the installation of a helmet to run Steam VR. On its first run, however, a serious problem was discovered. Moon-wreckers' open source code, Vive. Tracker, was released in 2018 and runs in Ubuntu 18.04 and ROS Indigo, using Python 2. The current operating environment is Ubuntu 20.04 and ROS Indigo, using Python 3 programming language, so there is a serious error in debugging. The vive\_tracker code does not support Python because it has not been updated. The new version of the triad\_OpenVR library function is not supported. Therefore, we adapted the vive\_tracker program to the latest triad\_OpenVR library function and made it work.

### **4.5TEST THE MOTION TRAJECTORY OF THE ROBOT**

After setting up the experiment site, start the power supply of Base Station Tracker successively, open the computer to enter Ubuntu, open Steam to log in SteamVR, SteamVR will search for Base Station and Tracker. Continue to open multiple terminals and run ROS projects such as vive\_Tracker and Grid\_map. Run the Rviz Visual debugging tool and add the tf and odometry controls to the Rviz tool. After the tf control is loaded, the Base Station and Tracker coordinate systems starting with LHB and LHR will appear on the main interface, as shown in Figure 8a, and the map and Vive\_World coordinate system icon will also appear. Continue loading the Map control on the Rviz tool, as shown in Figure 8b, and a grey, blank Occupancy Grid appears on the main page. At this point, the system is ready for testing.



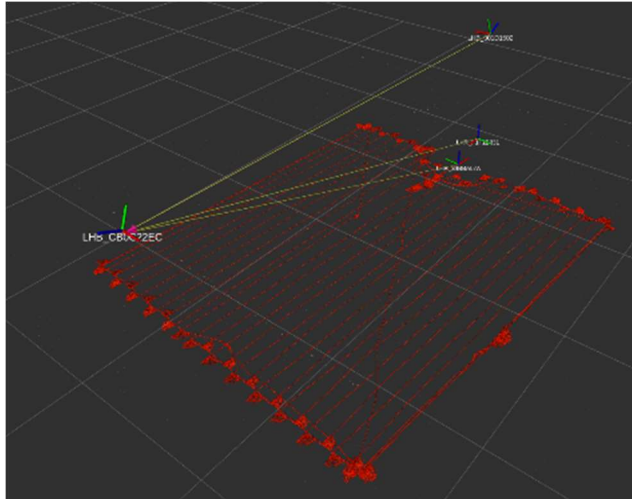

a. Odometry

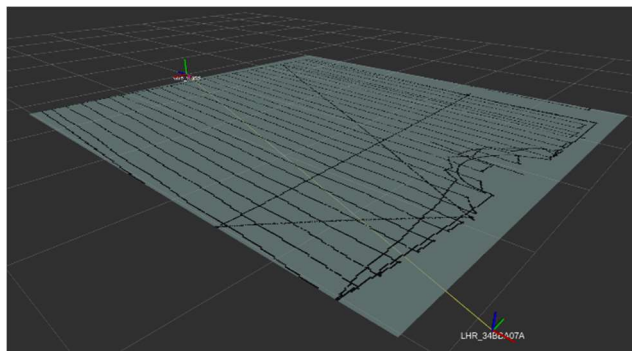

b. Occupancy grid

Figure 8. Test in ROS

At the beginning of the experiment, the power supply of the robot was turned on, and the robot was controlled to enter the sweeping state. The robot began to clean according to the planned path. As the robot starts to walk, the Odometry image of the robot starts to be updated. Odometry shows the running direction of the robot in the form of a small red arrow. Figure 8a shows the Odometry image formed by the robot during the whole cleaning process. It can be seen that the walking track is very clear and coherent, and there is no phenomenon of jumping due to the wrong position tracking. This shows that the accuracy of tracking robot trajectory measurement by Tracker can meet the test requirements and the performance is very stable. At the same time of Odometry image update, Occupancy Grid also marks the moved position of the robot according to the moving position of the robot. As shown in Figure 8b, the cover of the robot's walking track can be clearly seen.

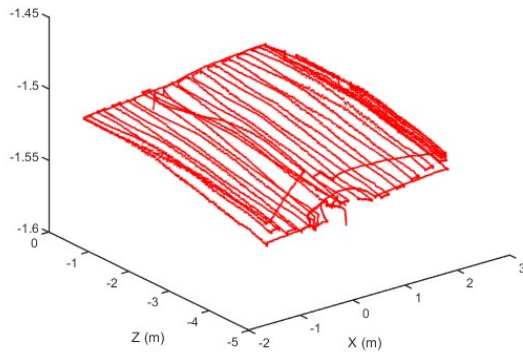

a. 3D curves

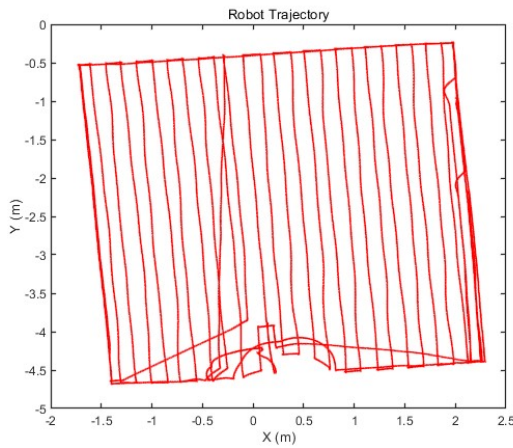

b. 2D curves

Figure 9. Trajectory curves

Data processing was carried out after the robot's walking path was derived. It can be seen from the three-dimensional curve in Figure 9a that the height difference of the robot walking ground was about 0.05m in a space of about 4m \* 4m. The test curve was continuous and inclined in one direction, which may be caused by the overall tilt of the ground or the BaseStation reference plane. And we did a number of experiments, and the results were always the same. In figure 9b, we can see the complete walking trajectory of the robot. The entire trajectory is located in the test space and has no random beating continuously. The test data is stable, which proves that the Tracker has the capability of trajectory testing.

## CONCLUSION

In this paper, HTC's Vive Tracker is used as the sensor for mobile robot motion tracking and capture, and the SteamVR and ROS platform architecture test system are adopted to complete the construction of the test platform and the compilation of the detection program, and finally the cleaning robot has been tested and verified. The test results shows that Vive Tracker has the ability to capture and analyze the mobile robot trajectory, which can meet the accuracy requirements of

mobile robot performance detection, and can be used for mobile robot performance analysis projects in scientific research or testing laboratories.

## REFERENCE

- [1] S. P. Kleinschmidt, C. S. Wieghardt, and B. Wagner, "Tracking Solutions for Mobile Robots: Evaluating Positional Tracking using Dual-axis Rotating Laser Sweeps," in *ICINCO* (1), 2017, pp. 155-164.
- [2] R. Amsters, E. Demeester, N. Stevens, Q. Lauwers, and P. Slaets, "Evaluation of low-cost/high-accuracy indoor positioning systems," in *Proceedings of the 2019 International Conference on Advances in Sensors, Actuators, Metering and Sensing (ALLSENSORS)*, Athens, Greece, 2019, pp. 24-28.
- [3] E. Rosen, D. Whitney, E. Phillips, D. Ullman, and S. Tellex, "Testing robot teleoperation using a virtual reality interface with ROS reality," in *Proceedings of the 1st International Workshop on Virtual, Augmented, and Mixed Reality for HRI (VAM-HRI)*, 2018, pp. 1-4.
- [4] R. Kupiec, R. Dubno, and J. Sb adek, "Accuracy assessment of a laser tracker system," 2013.
- [5] M. Topley and J. G. Richards, "A comparison of currently available optoelectronic motion capture systems," *Journal of Biomechanics*, vol. 106, p. 109820, 2020.
- [6] P. Bauer, W. Lienhart, and S. Jost, "Accuracy Investigation of the Pose Determination of a VR System," *Sensors (Basel, Switzerland)*, 10.3390/s21051622 vol. 21, no. 5, p. 1622, 2021.
- [7] S. Buckley. (2015). "This Is How Valve's Amazing Lighthouse Tracking Technology Works" [Online]. Available: <https://gizmodo.com/this-is-how-valve-s-amazing-lighthouse-tracking-technol-1705356768>.
- [8] Construction of a Hierarchical Feature Enhancement Network and Its Application in Fault Recognition, *IEEE Transactions on Industrial Informatics*, 2020.
- [9] Deep Fuzzy Hashing Network for Efficient Image Retrieval, *IEEE Transactions on Fuzzy Systems*, 10.1109/TFUZZ.2020.2984991, 2020.
- [10] V. Corporation. SteamVR [Online]. Available: <https://store.steampowered.com/steamvr>.
- [11] V. Corporation. Install Steam [Online]. Available: <https://store.steampowered.com/about/>.
- [12] R. Open. Ubuntu install of ROS Noetic [Online]. Available: <http://wiki.ros.org/noetic/Installation/Ubuntu>.
- [13] R. Open. UsingPython3 [Online]. Available: <http://wiki.ros.org/UsingPython3>.
- [14] C. Ltd. Ubuntu 20.04.2.0 LTS [Online]. Available: <https://ubuntu.com/download/desktop>.
- [15] w. Moon. HTC Vive Tracker Node for ROS [Online]. Available: [https://github.com/moon-wreckers/vive\\_tracker](https://github.com/moon-wreckers/vive_tracker).

## ACKNOWLEDGMENT

This research was funded by the projects of the Science and Technology Project of Jiangsu Market Supervision Administration (Grant Number: KJ196013) and the Fifth phase "333 Project" scientific research project of Jiangsu Province in 2020(Grant Number: BRA2020253).