



Design and Grasping Experiments of Soft Humanoid Hand with Variable Stiffness

Shulin Du, Qingchao Wang, Yan Zhao, Fuchun Sun, Xiao Lu,
Bin Fang and Shoucheng Hou

EasyChair preprints are intended for rapid dissemination of research results and are integrated with the rest of EasyChair.

October 22, 2020

Design and Grasping Experiments of Soft Humanoid Hand with Variable Stiffness

Shulin Du^{*1}, Qingchao Wang^{*1}, Yan Zhao^{*3}, Fuchun Sun^{✉2}, Xiao Lu^{✉1}, Bin Fang², Shoucheng Hou⁴

¹College of Electrical Engineering and Automation, Shandong University of Science and Technology, Qingdao, Shandong, People's Republic of China

²Department of Computer Science and Technology, Tsinghua National Laboratory for Information Science and Technology, Tsinghua University, Beijing, People's Republic of China

³ Shanghai Institute of Satellite Engineering

⁴China University of Geosciences Beijing

✉E-mail: fcsun@tsinghua.edu.cn; luxiao98@163.com.

Abstract: To improve the safety and adaptability of the human-machine and environment-machine interactions, the research of soft grippers has attracted much attention. In this study a novel Soft Humanoid Hand with Variable Stiffness(SHH-VS) is presented. The SHH-VS has 6 degrees of freedom, and the design of the soft finger with variable stiffness adopts the principle of layer blocking. The SHH-VS can complete grasping, pinching, holding, lifting and other multi-skill grasping operations, using the tendon-driven mechanism. Tactile sensors are installed at the fingertips, which can realize real-time feedback of tactile information. The SHH-VS has better flexibility, greater grasping power, and multi-skill grasping ability. Through a number of grasping experiments, it has been verified that the SHH-VS has greater reliability and safety, and can be used in various daily situations.

Keywords: soft humanoid hand, variable stiffness, multi-skill grasping, tactile sensor, grasping experiments

1 Introduction

As an important end effector of the robot, the manipulator plays a very important role in the field of the robot, it can accomplish various operations like grasping, pinching, holding and lifting. Robots equipped with the manipulator are able to complete tasks such as item classification and assembly. The main components of traditional manipulators are rigid connecting rods, while the working space is limited, the safety is difficult to guarantee when interacting with people. Moreover, It is hard to grasp the objects without causing damage in the picking and sorting of objects with soft and fragile surfaces. Therefore, complex force closed-loop control algorithms and expensive sensing devices are indispensable, for rigid manipulators, to achieve compliant operation. In recent years, to improve the safety and adaptability of the human-machine and environment-machine interactions, the research of soft grippers has attracted much attention. Mechanical Engineering Department of Korea Advanced Institute of Science and Technology(KAIST)has proposed a novel variable-stiffness mechanism inspired from the connected ossicle structure of an echinoderms body wall which can overcome the limitations of the existing methods. The

structure of the echinoderms body wall can induce a change of stiffness, and based on this feature, they developed a structure-based vacuum driven mechanism applicable to soft robot with elastomerfoam and ossicles[1]. Computer Science and Artificial Intelligence Laboratory of Massachusetts Institute of Technology has proposed a soft hand capable of robustly grasping and identifying objects based on internal state measurements along with a combined system which autonomously performs grasps. A highly compliant soft hand allows for intrinsic robustness to grasping uncertainties; the addition of internal sensing allows the configuration of the hand and object to be detected[2]. The Soft Robot Laboratory at the Robotics Department of Ritsumeikan University in Japan has proposed a dual-mode soft gripper that integrates a suction pad on the tip of each pneumatic actuator. By combining the advantages of both grasping and suction, the proposed gripper can handle a wide variety of objects[3]. The School of Mechanical Engineering and Automation, Beihang University incorporated vacuum-actuated suckers into the actuators for the production of a fully integrated octopus arm-inspired gripper[4].

^{*}denotes the same contributions; [✉]Corresponding author: fcsun@tsinghua.edu.cn; luxiao98@163.com.

The driven methods of manipulators is also the focus of research in the field of manipulators, and remarkable achievements have been made in recent years, such as pneumatic actuators [5,6], chemical reaction [7], the tendon-driven mechanism [8,9], shape memory alloy actuators [10] and so on. Compared with other driven methods, tendon line driven has better response efficiency and frequency[11]. The soft manipulator is made of flexible material with shape adaptability, which can realize the smooth operation and is suitable for grasping operation tasks. In recent years, more and more scientists have participated in the research of soft humanoid hand[12-15]. Compared with traditional manipulators, soft humanoid hands are light in weight, low in cost, simple to drive, and easy to manufacture. Both in collaboration and interaction, they have higher security.

In this paper, a novel Soft Humanoid Hand with Variable Stiffness(SHH-VS) is presented[16,17]. The SHH-VS has 6 degrees of freedom, of which the thumb has two and each of the other fingers has one. The design ensures it can grasp objects of various sizes, and is able to complete more complex tasks. We achieve the variable stiffness performance of the SHH-VS by the layer blocking principle, and adopt the tendon-driven mechanism to control the soft fingers, which makes the heavy objects grasped. Moreover, the SHH-VS can also increase the possibility for human-robot communication based on the gestures.

2 Design of the Soft Humanoid Hand with Variable Stiffness

2.1 Principle of the variable stiffness

In this paper the layer blocking principle is used to realize the variable stiffness performance of the SHH-VS. There is a sealed cavity along the length of the finger inside it. A blocking component (multi-pieces of layer jamming structure) for adjusting the stiffness is placed in the cavity. And there is a certain deformation space between the blocking component and the accommodating cavity, which is communicated with the negative pressure device through the tube. In the process of finger deformation, the multi-pieces of layer jamming structure is squeezed and rubbed against each other in the longitudinal and transverse directions, thus the rigidity of the soft finger becomes larger. Especially after the cavity is evacuated, the layer blocking effect is optimal. **Fig.1** shows the prototype of the soft finger with variable stiffness.

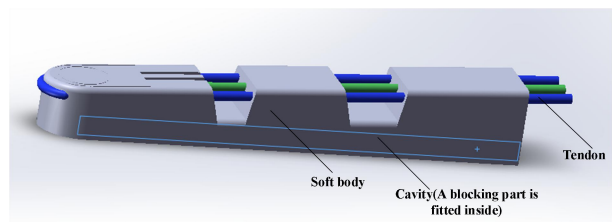

Fig.1 . Prototype of the soft finger with variable stiffness

2.2 Design of the SHH-VS

The overall design of the SHH-VS copied the shape of the human hand(**Fig.2**),and adopts the method of tendon line driven. The motors that provide power are assembled in the palm (**Fig.3**) to control the transmission of the tendon line, thereby controlling the fingers. The SHH-VS has 6 degrees of freedom, including two for the thumb and four for the other fingers, which can accomplish under-actuation and coupling of the finger. Thus the SHH-VS has good adaptability. The stiffness of the finger can be changed, making the SHH-VS adapted to grasp heavy objects. The fingertip is equipped with a tactile sensor, which can obtain the grasping force in real time, so that the SHH-VS can accomplish a variety of grasping operations with high precision.

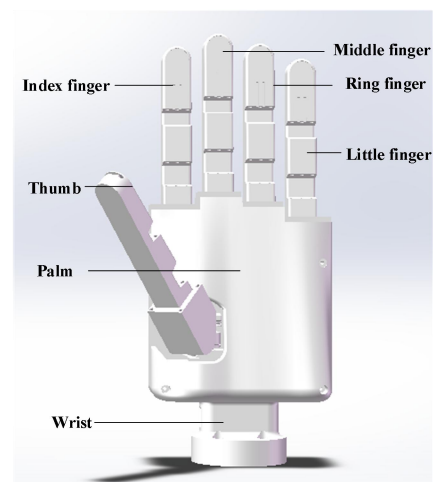

Fig.2. Prototype of the SHH-VS assembled with five soft fingers

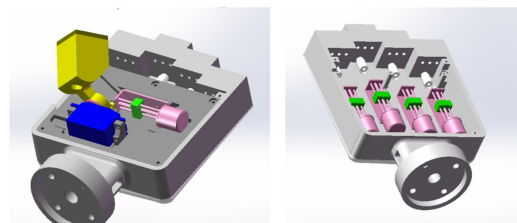

Fig.3. The internal structure of the palm

The soft fingers are made of soft material. In order to fully simulate the human hand and simplify the structure, the fingers are designed in three segments, which are jointly controlled by a shared tendon line. This design can accomplish under-actuation and coupling of the finger. The structure of the

index, middle, ring and little finger is the same in this paper. Take the index finger as an example, it has 3 phalanges, and they are proximal phalanx, middle phalanx, and end phalanx. (Fig.4)The line routing adopts a "U-shape" instead of the straight, mainly to make it easier to pull the soft finger to bend. At the same time, there is a plastic hose in the tendon cavity to reduce the friction between the tendon line and the cavity to ensure the service life.

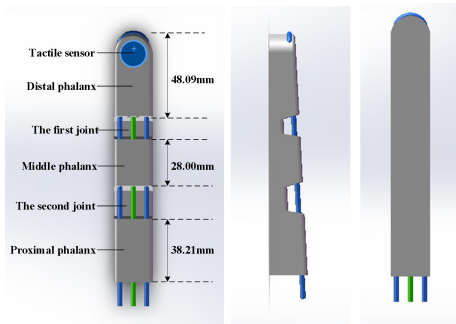

Fig.4. Prototype of the index finger

There is a thin-film tactile sensor at the phalanx of the index finger(Fig.5), which is encapsulated by a layer of transparent silica gel. The wire of the sensor embedded in the plastic hose of the cavity, and extends to the interface module of control board to acquire tactile signals.The sensor consists of two very thin polyester films with conductors and semiconductors laid on the inner surface of the two films,which can measure the pressure of any contact surface statically and dynamically. The sensor converts the pressure applied to the sensing area into a resistance signal, and then obtains the change information of the external pressure according to the force-resistance calibration curve. The greater the pressure, the smaller the resistance output by the sensor.

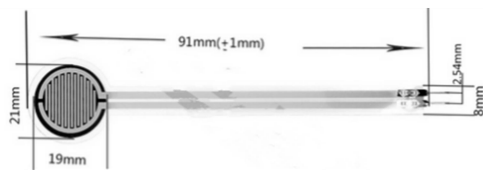

Fig.5. The Tactile sensor

The thumb(Fig.6) is the most important of the human hands. Almost all grasping operations require the cooperation of the thumb.Common actions of human hands, such as grasping, pinching, holding,and lifting, all require complete force closure and geometric closure to hold the target stably. The design of the thumb determines the working space, operation and gripping stability of the entire system. Similar to the index finger, the thumb is also composed of 3 phalanges. One more base joint is added. The thumb has 2 degrees of freedom, namely the flexion/extension of the finger and the rotation of the base joint.The base joint can be rotated within 0-90° and reach the position between the index and the middle finger.

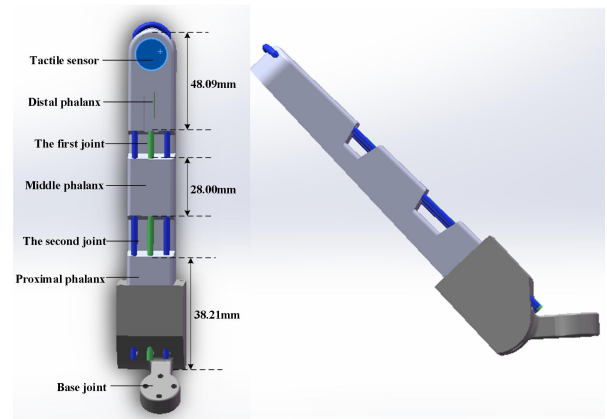

Fig.6. Prototype of the thumb finger

The palm(Fig.7), as the main supporting part of the soft finger, is made by 3D printing. There are four sockets on the top of the palm for fixing the soft fingers. It is packaged with silica gel. After cooling, the fixing strength and sealing performance between the fingers and the sockets increased. The palm is mainly used to place the transmission devices, air nozzle, tendon line, wire and tube.At the same time, the transmission device of the thumb is designed on the support plate which assembled on the palm.For the beauty of the palm, we designed the front and back of the palm to make it smooth.

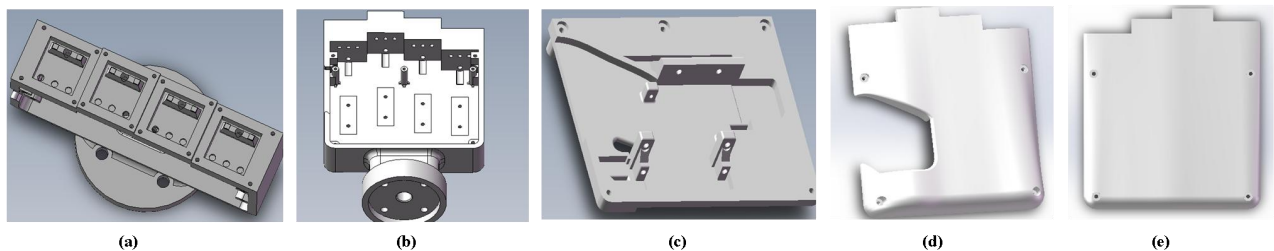

Fig.7. The structure of the palm. (a) The rabbet of the distal phalanx. (b) The internal structure of the palm.(c) The support plate of the thumb.(d) The front of the palm.(e) The back of the palm.

2.3 The control system of the SHH-VS

The control system of the SHH-VS is an embedded system(Fig.8), and the model of the main chip is STM32F103RCT6. The SHH-VS system consists of two parts: the software system(Host computer) and the Hardware system, and uses UART for real-time communication. The hardware system mainly receives control commands from the software system to output PWM digital signal, which are used to control the work of each steering gear, stepper motor, vacuum pump and electromagnetic valve, and upload the data of each tactile sensor to the host computer.

The hardware system mainly includes four parts: control circuit, drive circuit, signal acquisition circuit and power supply circuit. The whole system is integrated on a control board. The control circuit is used to generate control commands. The drive circuit is used to drive the devices. The acquisition circuit is used to acquire the tactile data and feed back changes in the grasping force during the grasping process. The power supply circuit provides sufficient power for some actuators and the minimum system of the main controller.

The hardware connection of the SHH-VS is shown in Figure.11. There are 8 interface modules: (1) STM32 Virtual

COM Port module, which is connected to the host computer. The interface receives control instructions and query instructions sent by the host computer, and feeds back the current tactile data. (2) USB Serial CH340 module, which is connected to host computer, providing download interface of the control program. (3) The 12V power supply module, which is connected to the switching power supply. The 12V voltage is divided into two functions. One is supplied to the stepper motor drive modules, and the other is reduced to 5V and 3.3V supplied to chip after stepping down. (4) 24V power supply module, which is used to supply power for vacuum pump and electromagnetic valve. (5) The control module for vacuum pump and electromagnetic valve, which is used to switch them to realize the variable-stiffness operation of the fingers. (6) The driver module of stepper motors, which is connected with stepper motors to control the flexion/extension of the fingers. (7) The control module of steering gear, which provides power and control commands for the steering gear. (8) The tactile-data acquisition module, which is connected with the tactile sensors of the the SHH-VS to acquire five-channel tactile data.

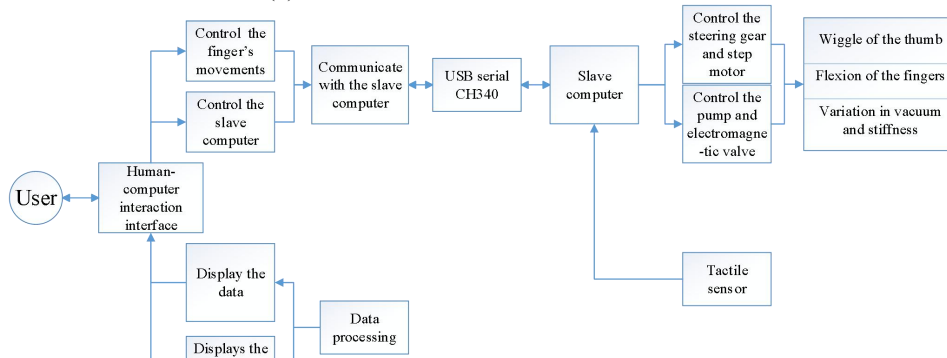

Fig.8. Control strategy of the SHH-VS system

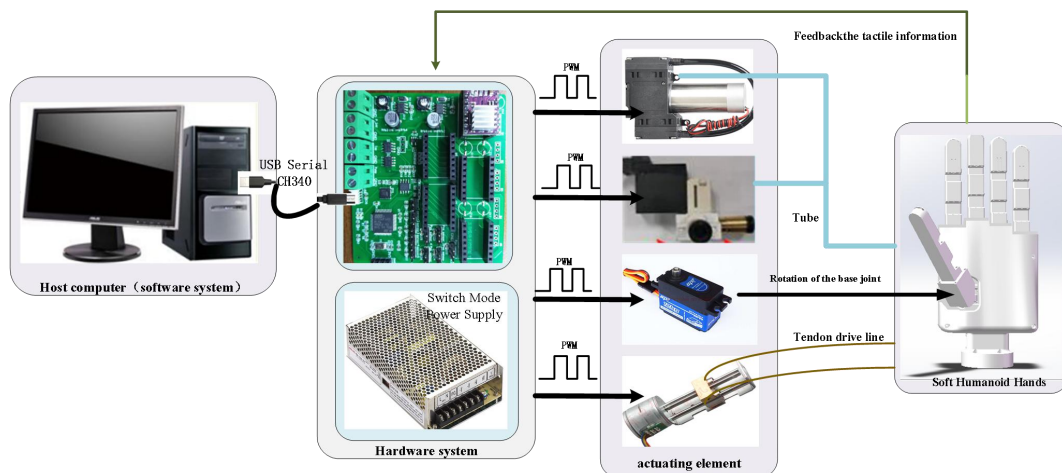

Fig.9. Hardware connection of the SHH-VS control system

3 Experiment

3.1 Gesture experiment of the SHH-VS

The SHH-VS can make a variety of common gestures(Fig.10),such as number gesture “0”, “1”, “2”, “3”, “4”, “5”, “6”, “8” as well as gesture “OK”.

3.2 Grasping experiment of the SHH-VS

SHH-VS has a certain limitation when making gestures because of the under-actuated structure, but outstanding performance in the grasping experiments. When grasping an object, the under-actuated structure and the compliance of the finger make SHH-VS have self-adaptability ,so that it can achieve compliant operation, especially it can grasp the fragile object without damage(Fig.11(a),(b)grabbing the egg and balloon). The main function of the SHH-VS is to accomplish the multi-skill operations such as grasping, pinching, holding

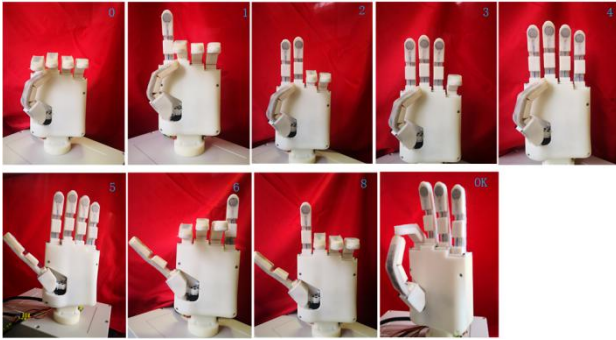

Fig.10. Experiments of the common gesture

and lifting, at the same time it can acquire the tactile data(Fig.12). Table 1. shows the parameters of the items used in the experiments. When grasping, set the swing angle of the thumb according to the shape and size of the target object to match the other four fingers, then the SHH-VS can accomplish the grasping of cuboid, cylinder, sphere, hemisphere and irregular objects(Fig.11).

When pinching, because of the effective cooperation of the thumb, index finger and middle finger, a force seal is formed between the fingertip and the objects, which makes the SHH-VS can complete pinching objects with two or three fingers(Fig.13). The results of the experiments show that the SHH-VS acts flexibly, has good adaptability to the shape of different objects, and can smoothly grasp a variety of objects.

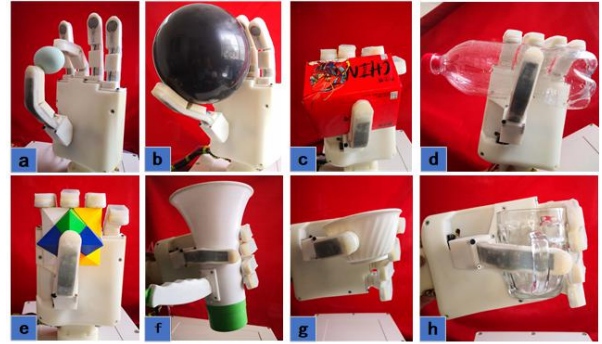

Fig.11. Experiments of grasping a variety of objects with two or five fingers

Table 1 Grab item parameter table

Item	Quality/g	Size/mm	Item	Quality/g	Size/mm
folding megaphone	900	$d_{max}=146, d_{min}=73, h=240$	egg	65	$d=43, h=62$
card	5.40	$V=85*55*1$	balloon	1.8	$d=170$
wallet	125.44	$V=115*90*20$	cuboid	119	$V=120*90*70$
cookies	29.25	$V=90*45*20$	bottle	500	$d=55, h=220$
bread	26.61	$V=100*70*35$	glass cup	291	$d=75, h=90$
handbag	1500	$V=220*90*160$	irregular toy	80	$d=100$
kettle	1500	kettle handle: $V=140*30*15$	ball	30	$d=60$
bowl	31.20	$d_{max}=115, d_{min}=55, h=40$			

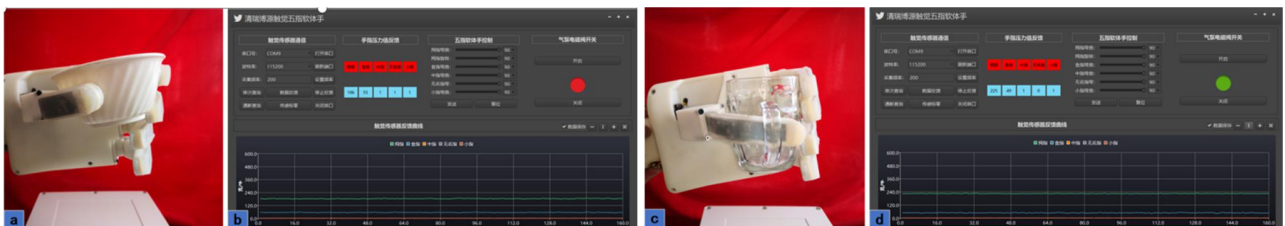

Fig.12. Experiments of acquiring the tactile information

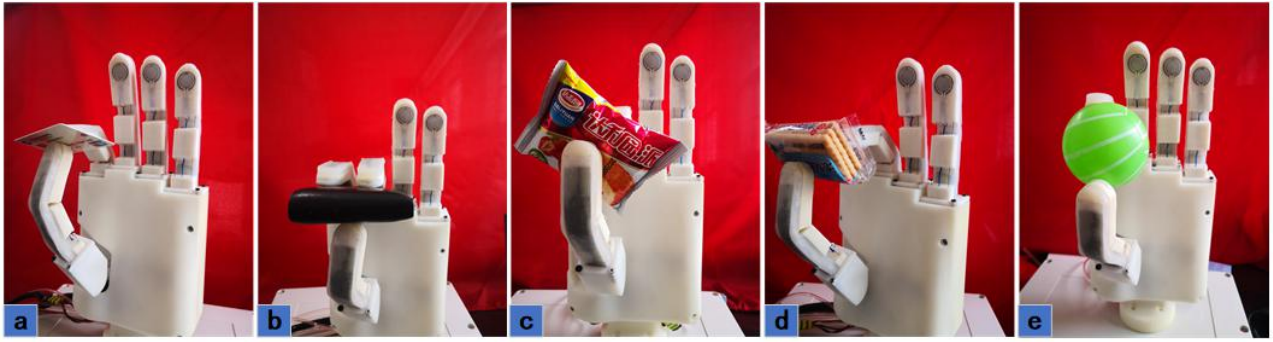

Fig.13. Experiments of pinching different objects

3.3 Application experiment of the SHH-VS

In the grasping experiments, the SHH-VS shows its stable and flexible grasping ability. Moreover, it can also accomplish some operations similar to the human hand, which is not available in ordinary soft grippers. **Fig.14** demonstrates the process of a bowl(500g) being held in the palm. That is a process of human-machine interaction. **Fig.15** demonstrates the process of a handbag being lifted **Fig.16** and **Fig.17** respectively shows the process of picking up the kettle and pouring water. The above experiments have again verified the good grasping performance of the SHH-VS and its advantages in structure.

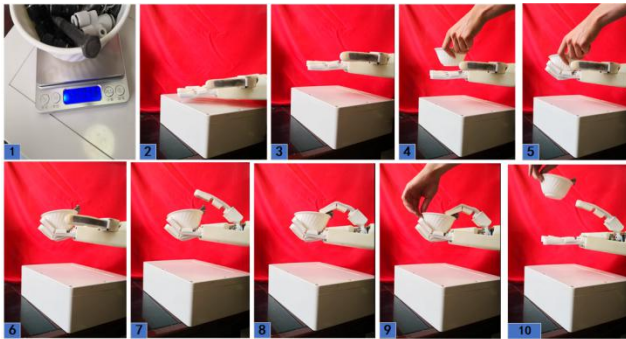

Fig.14. Demonstration of bowl(500g)being held in the palm

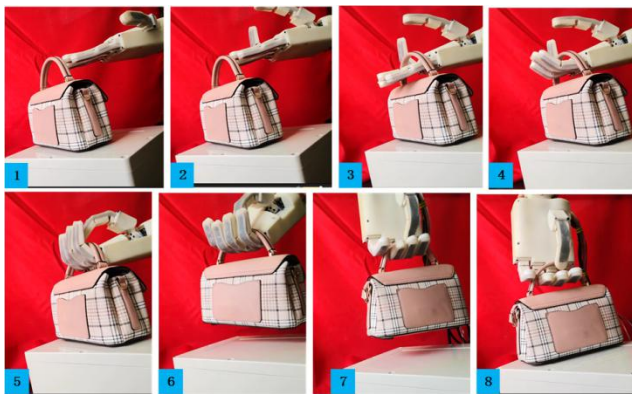

Fig.15. Demonstration of the handbag being lifted



Fig.16. Demonstration of the kettle being picked up

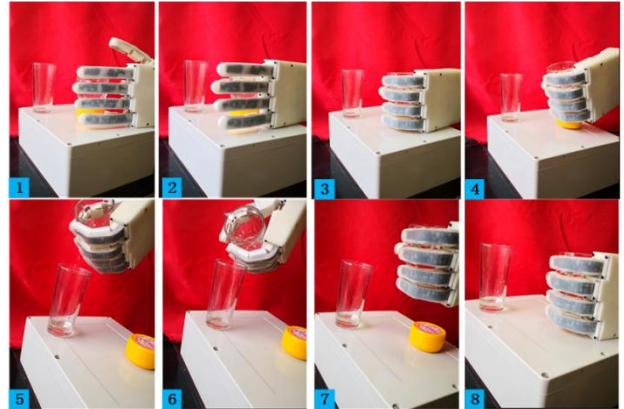

Fig.17. Demonstration of pouring water

4 Conclusion

This paper designed a novel Soft Humanoid Hand with Variable Stiffness(SHH-VS)that capable of multi-skill grasping. The SHH-VS has 6 degrees of freedom, of which the thumb has two and each of the other fingers has one.The layer blocking principle is used to realize the variable stiffness performance,and the tendon-driven is used to realize the movement of the fingers. One servo controls the rotation of the thumb, and five stepper motors control the transmission of the tendon line to achieve the flexion of fingers.It can complete grasping, pinching, holding, lifting and other operations. The results of the experiments show that it can grasp various objects well, and the soft material ensures that the surface of the grasped objects is completely undamaged. The fingertip is equipped with a tactile sensor, which can display real-time tactile information through the interface of the host computer. Moreover, the SHH-VS can make a variety of common gestures, which improves the human-machine interaction.

5 References

- [1] H. Jeong and J. Kim, "Echinoderm Inspired Variable Stiffness Soft Actuator with Connected Ossicle Structure," 2019 International Conference on Robotics and Automation (ICRA), Montreal, QC, Canada, 2019, pp. 7389-7394.
- [2] Homberg, BS ,Katzschmann,et al.Robust proprioceptive grasping with a soft robot hand[J].Autonomous Robots,2019,43(3):681-696.
- [3] Zhongkui Wang,Keung Or,Shinichi Hirai. A dual-mode soft gripper for food packaging[J]. Robotics and Autonomous Systems,2020,125.
- [4] Xie Zhexin,Domel August G,An Ning,Green Connor,Gong Zheyuan,Wang Tianmiao,Knubben Elias M,Weaver James C,Bertoldi Katia,Wen Li. Octopus Arm-Inspired Tapered Soft Actuators with Suckers for Improved Grasping.[J]. Soft robotics,2020.
- [5] Guoliang Zhong,Yangdong Hou,Weiqiang Dou. A soft pneumatic dexterous gripper with convertible grasping modes[J]. International Journal of Mechanical Sciences,2019,153-154.
- [6] P. Polygerinos et al., "Modeling of Soft Fiber-Reinforced Bending Actuators," in IEEE Transactions on Robotics, vol. 31, no. 3, pp. 778-789, June 2015, doi: 10.1109/TRO.2015.2428504.
- [7] Wehner Michael,Truby Ryan L,Fitzgerald Daniel J,Mosadegh Bobak,Whitesides George M,Lewis Jennifer A,Wood Robert J. An integrated design and fabrication strategy for entirely soft, autonomous robots.[J]. Nature,2016,536(7617).
- [8] Mishra,A.K., Del Dottore,E., Sadeghi,A., et al.: ' SIMBA: tendon-driven modular continuum arm with soft reconfigurable gripper', Front. Robot. AI,2017,4,(4)
- [9] AI Abeach,L., Nefti-Meziani,S., Theodoridis,T., et al.: 'A variable stiffness soft gripper using granular jamming and biologically inspired pneumatic muscles',J. Bionic Eng.,2018,15,(2), pp.236-246
- [10] Kim,JS;Jang-Yeob Lee,Kyung-Tae Lee,Hyung-Soo Kim,Sung-Hoon Ahn. Fabrication of 3D soft morphing structure using shape memory alloy (SMA) wire/polymer skeleton composite[J]. Journal of Mechanical Science and Technology,2013,27(10).
- [11] K. Mizushima, T. Oku, Y. Suzuki, T. Tsuji and T. Watanabe, "Multi-fingered robotic hand based on hybrid mechanism of tendon-driven and jamming transition," 2018 IEEE International Conference on Soft Robotics (RoboSoft), Livorno, 2018, pp. 376-381, doi: 10.1109/ROBOSOFT.2018.8404948.
- [12] Zhao H, Huang R, Shepherd R F. Curvature control of soft robotics via low cost solid-state optics[C]. Stockholm. International Conference on Robotics and Automation. IEEE, 2016: 4008-4013.
- [13] Zhao H, Jalving J, Huang R, et al. A helping hand: Soft orthosis with integrated optical strain sensors and EMG control[J]. IEEE Robotics & Automation Magazine, 2016, 23(3): 55-64.
- [14] Zhong G, Hou Y, Dou w. A soft pneumatic dexterous gripper with convertible grasping modes[J]. International Journal of Mechanical Sciences,2019,153-154.
- [15] Al-Rubaiai M, Pinto T, Qian C, et al. Soft actuators with stiffness and shape modulation using 3D printed conductive polylactic acid material[J]. Soft robotics, 2019, 6(3): 318-332.
- [16] Feng N, Shi Q, Wang H, et al. A soft robotic hand: design, analysis, sEMG control, and experiment[J]. The International Journal of Advanced Manufacturing Technology, 2018, 97(1-4): 319-333.
- [17] Ham K B, Han J, Park Y J. Soft gripper using variable stiffness mechanism and its application[J]. International Journal of Precision Engineering and Manufacturing, 2018, 19(4): 487-494.