



Study on EAHE System Combined with Several Components in the Medan City

Johandhi Setyawan Purba, Tulus Burhannuddin Sitorus,
Sumardani Harum Sukarta Surbakti, Willy Ogam Daniel Hutabarat
and George Joshua Yudha Saragi

EasyChair preprints are intended for rapid dissemination of research results and are integrated with the rest of EasyChair.

November 8, 2021

Study On EAHE System Combined With Several Components In The Medan City

J S Purba¹, T B Sitorus^{2*}, S H S Surbakti³, W O D Hutabarat⁴, and G J Yudha⁵

^{1,2,3,4,5}*Department of Mechanical Engineering, Universitas Sumatera Utara, Jalan Dr. T. Mansur No.9, Padang Bulan, Kec. Medan Baru, Kota Medan, Sumatera Utara 20222*

*Corresponding author: tulus.burhanuddin@usu.ac.id

Abstract. Energy demand for space cooling and heating in buildings is a primary contributor to the total building energy consumption. Its rapid increase calls for an urgent need to utilize renewable energy sources and associated energy-efficient technology in the building sector. Among different renewables, geothermal energy has been widely adopted due to its easy access and low impact on the environment. The method for this research uses EAHE (Earth-Air Heat Exchanger) and utilization of solar energy as air conditioning. The study aimed to determine the variation in output temperature of EAHE for each given mass flow rate, the efficiency of the solar collector, the efficiency of the solar chimney and output power, and the efficiency of photovoltaics as a blower current source. In this study, ambient air is circulated into the pipe with a speed varying at 3 m/s and 2 m/s. From the experimental results obtained that at an incoming airspeed of 3 m/s obtained the average output temperature for the experimental results of 27.93 °C with an average entry temperature of 33.79 °C. While for the entry air speed of 2 m/s obtained the average output temperature for the experimental results of 28.81 °C with an average entry temperature of 32.15 °C. The effectiveness of this heat exchanger was obtained by 81.34% for the entry air speed of 3 m/s and 77.19% at 2 m/s. The efficiency of solar collectors was obtained by 79.76%, and the efficiency of solar chimney was obtained by 58.38%. As well as the output power of the first photovoltaic of 50.03 Watts with an efficiency of 9.82% and from the second photovoltaic of 50.84 Watts with an efficiency of 10.33%.

INTRODUCTION

Humanity always needs comfortable environmental conditions in a building. However, energy is required to maintain the ecological conditions in a comfortable facility. Currently, energy consumption for buildings reaches 25-40% of the world's total energy consumption. Most of the energy is spent heating or conditioning the air and comes from fossil fuels such as coal, oil, and gas. The need for sustainable development encourages people to seek alternative, renewable energy to condition the environment in a building[1].

Due to the increasing human need for comfortable air, rising energy prices, and environmental problems, people are vying to find a renewable energy-based system capable of answering all these challenges. One solution that can be developed is to utilize the energy stored in the soil (earth energy). This energy can be used as a ventilation or air conditioning system by using a tool called an air-ground heat exchanger or EAHE (Earth-Air Heat Exchanger)[1].

The ground-air heat exchanger system (EAHE) is one promising technique that can effectively heat the air in winter and vice versa in summer. The earth's temperature at a depth of 1.5 to 2 m remains relatively constant throughout the year. This constant temperature is called Earth's Undisturbed Temperature (EUT). EUT remains higher than the ambient air temperature in winter and lower than the ambient air temperature in summer. The performance of the air-ground heat exchanger system depends on the diameter of the pipe, the length of the pipe, the pipe material, moisture content, soil characteristics, temperature in the relation between the earth and ambient air. Pipe material must have high thermal conductivity, such as mild steel, PVC pipe, and cement pipe. Underground soil temperature is mainly influenced by climatic conditions and soil characteristics in a location[2].

An air-ground heat exchanger (EAHE) consists of one or more underground pipes to supply air conditioning to buildings. The phenomenon is quite simple and depends on the temperature difference between the soil and the ambient air. Environmental air is flowed into underground-grown pipes using blowers and experiencing direct heat transfer with the soil.

Efforts to develop heat transfer system methods in this soil layer in addition to low-cost room cooling are also expected to improve the environment by reducing the level of CFC (Chloro-Fluoro-Carbon) in air-conditioned machines such as air conditioners.

METHODOLOGY

Place and Time

The research was conducted in the city of Medan city in April 2021.

Design Method

In conducting this research, the activities carried out are :

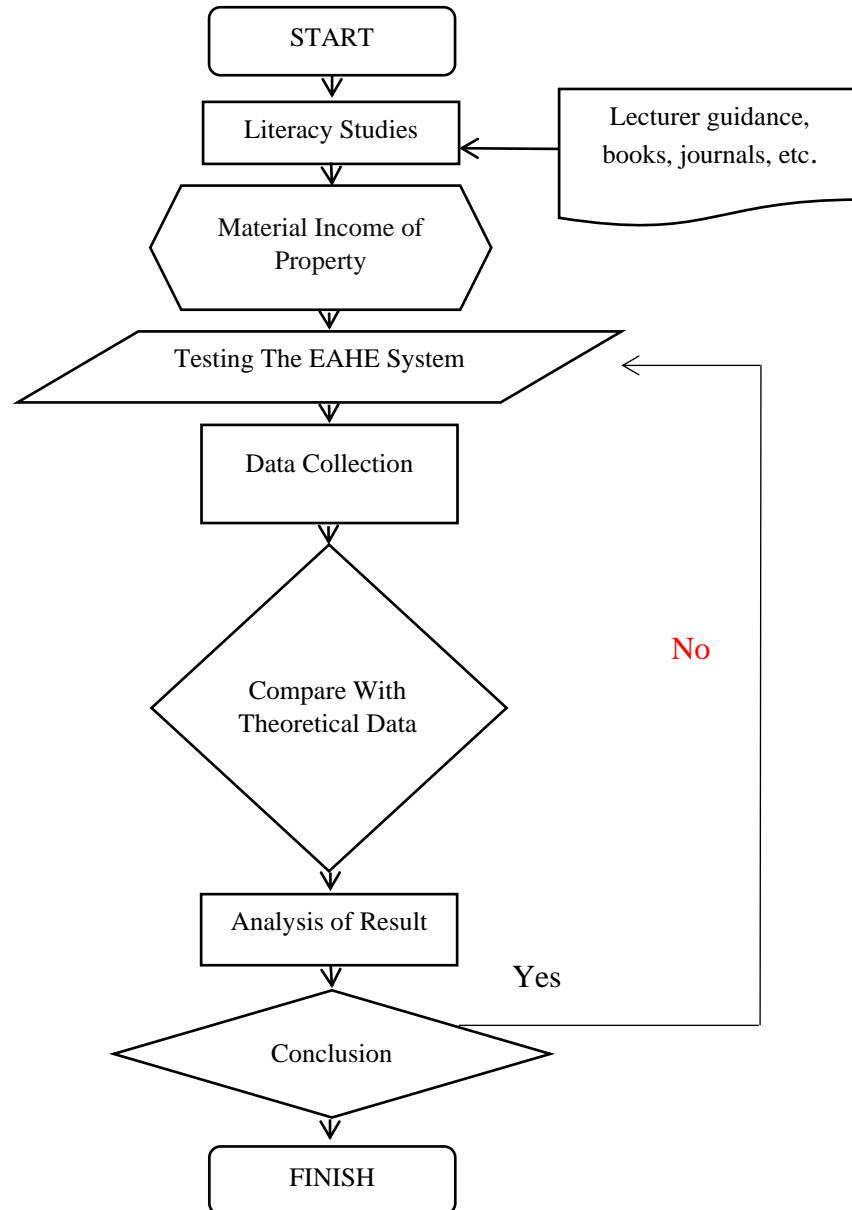

FIGURE 1.Flow Chart

Research Methodology

Based on figure 2, this research aims to reduce the ambient air temperature by using a ground-air heat exchanger, or Earth-Air Heat Exchanger (EAHE), using a solar collector, solar chimney, photovoltaic. The beginning of cooling starts from the inlet of air from the EAHE inlet using a blower speed of 3 m/s and 2 m/s with a current source from photovoltaics. After the air is delayed due to circulation in EAHE, the air is forwarded through the outlet pipe into the room. The air that enters the room is the air used as air conditioning. Due to the difference in cold air temperature with heat and pressure difference, air will flow to the outlet side of the room. Solar collectors that heat the air flowing will result in different pressures on the indoor side and the solar collector itself so that the air will undergo circulation automatically, and then the hot air will be passed to the solar chimney. Hot air has a relatively light density, so it will be weathered upwards, or hot air will come out through the chimney outlet.

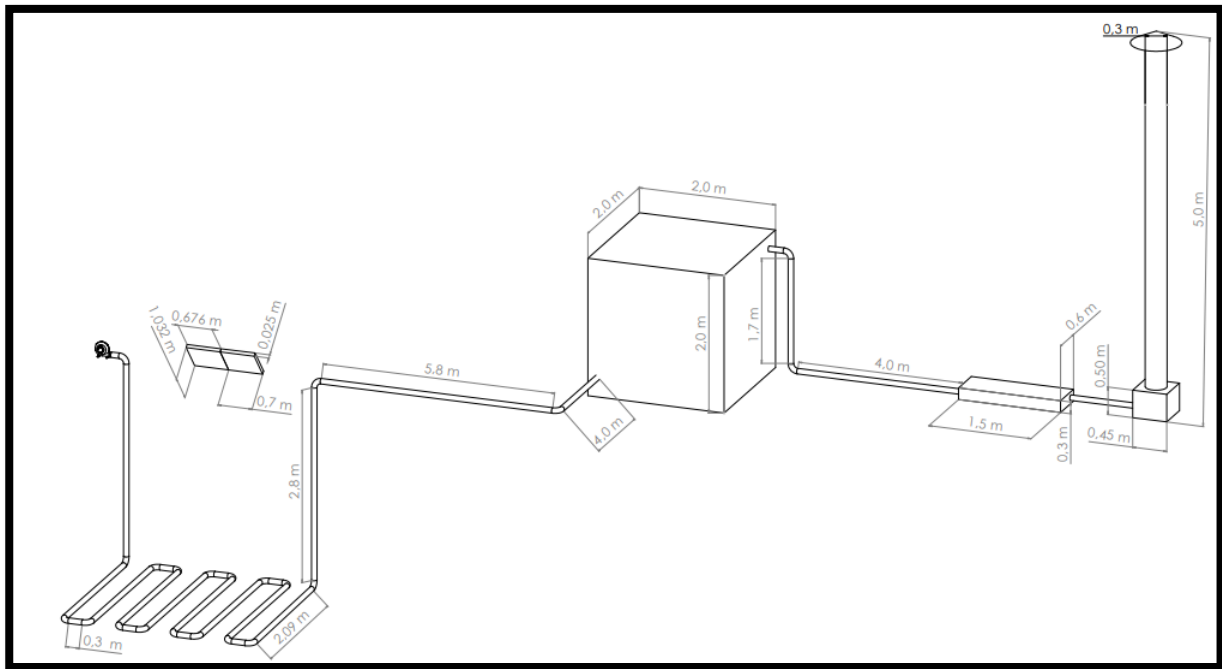

FIGURE 2.Design Schem

Specifications :

- EAHE pipe material: PVC pipe
- EAHE pipe diameter: 7.62 cm
- EAHE depth: 2.5 m
- Test room material: bricks
- Wall thickness: 100 mm
- Solar collector material: Aluminum
- Thick glass collector: 5 mm
- The thickness of absorber plate: 1 mm
- Chimney solar material: Zinc
- The thickness of solar chimney: 1 mm
- Photovoltaic material: Aluminum
- Photovoltaic models: SA100-72M and HQ 100
- Max power: 100 Watts
- Voc: 22.7 Volts and 22.4 Volts
- Isc: 5.8 Ampere
- Blower Model: NRT-PRO
- RPM without loading: 3000 RPM
- Blower voltage: 220 V, 1 phase
- Blower current: 1

TEST RESULT

The tests carried out discussed the conditions of the EAHE inlet, outlet air temperature and effectiveness, solar collector efficiency, solar chimney efficiency and photovoltaic efficiency.

EAHE Output Temperature Towards Test Room

The description below is the result of 4 days of test data, with a speed of 3 m/s on the first 2 days and a speed of 2 m/s in the last 2 days.

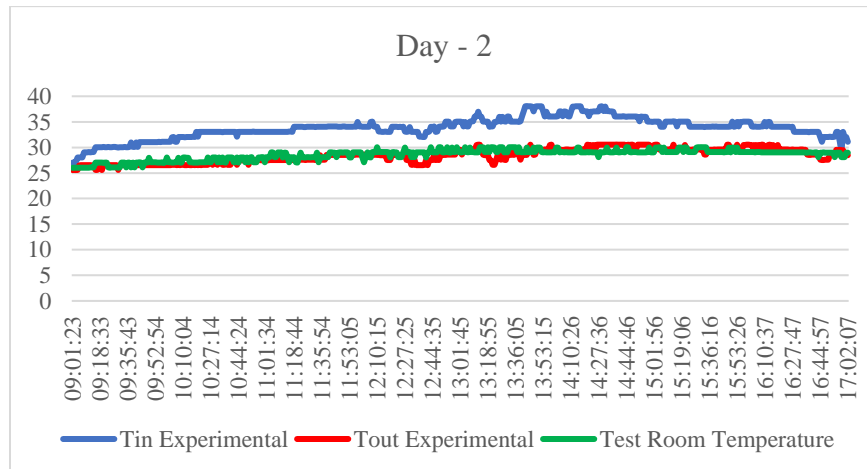
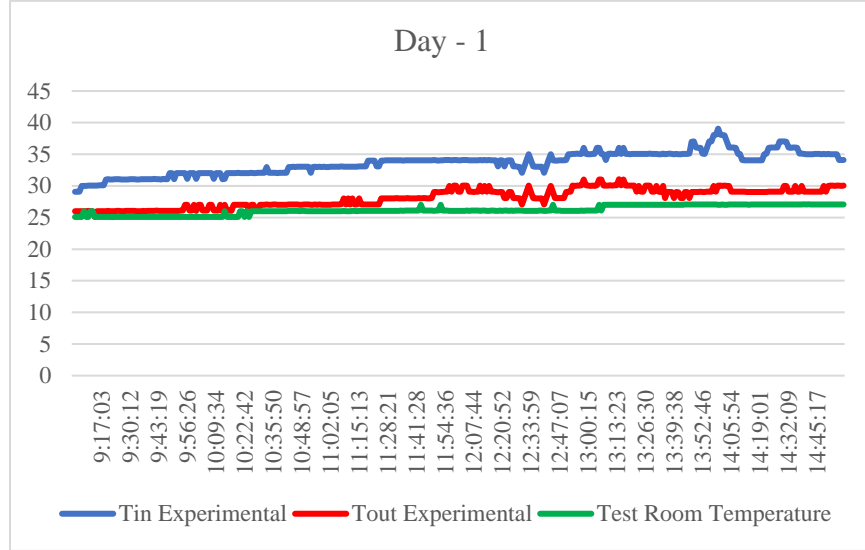

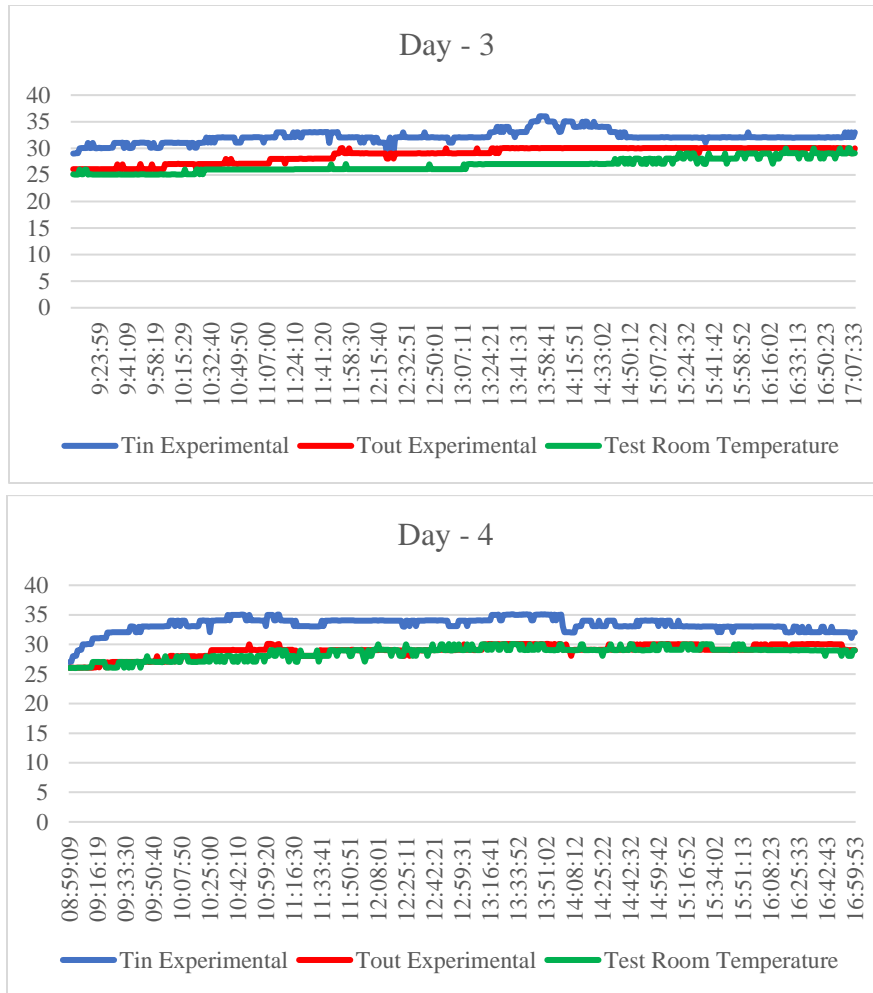

FIGURE 3. Output Temperature Graph versus Test Room

From the graphic picture above, it can be seen that the room temperature is quite stable due to the performance of EAHE and the experienced temperature fluctuations of almost 1°C. Meanwhile, EAHE's entry temperature is higher than EAHE's outgoing temperature.

Effectiveness of EAHE

The effectiveness of EAHE can be determined by using the formula below [3]:

$$\varepsilon = 1 - e^{-NTU} \quad (1)$$

information :

ε = Effectiveness
 NTU = Number Transfer Unit

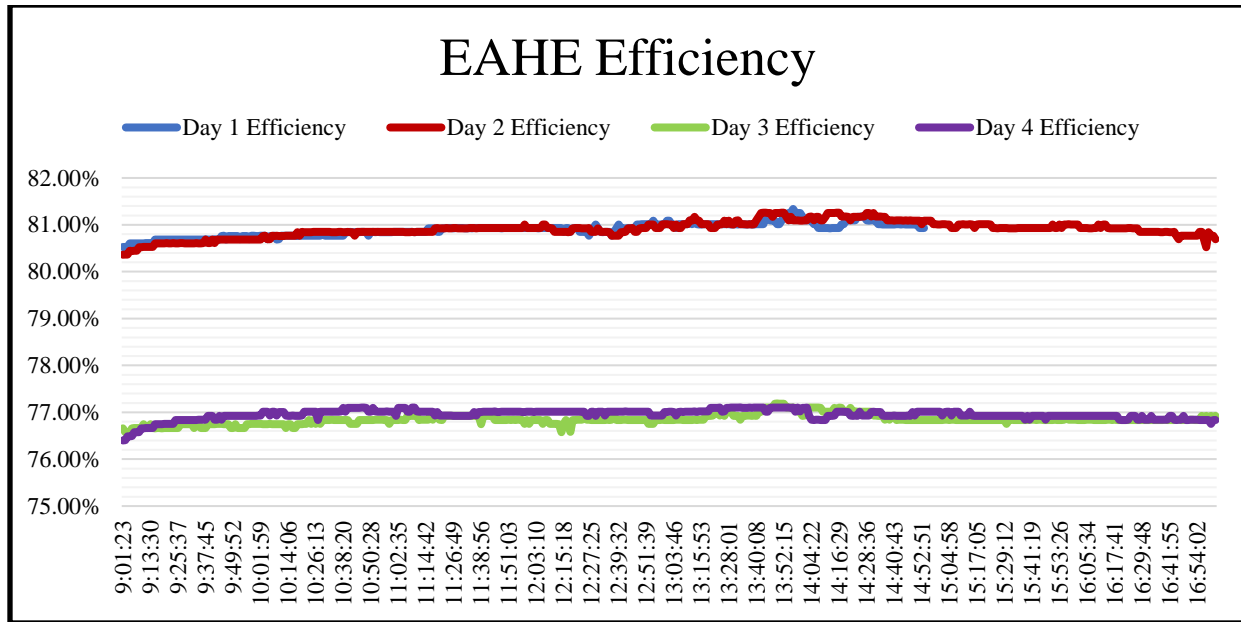

FIGURE 4.EAHE Effectiveness Graph

As figure 4 has shown, the effectiveness of eahe at 3 m/s is higher than at 2 m/s, because the value of NTU at 3 m/s is higher than at 2 m/s. The higher the NTU value, the more effective it will be. NTU values will increase as h_{conv} values increase and the surface area of the inner pipe walls. And the highest effectiveness at the speed of 3 m/s is 81.34 % on day 1, and for the speed of 2 m/s, that is, 77.19 % on day 3.

Solar Collector Efficiency

The efficiency of solar collectors can be determined by the following equation [4]:

$$\eta = \frac{Q_b}{IA} \times 100\% \quad (2)$$

information :

- Q_b = Heat used by collectors (Watt)
- I = Intensity of solar radiations (W/m²)
- A = Surface area (m²)

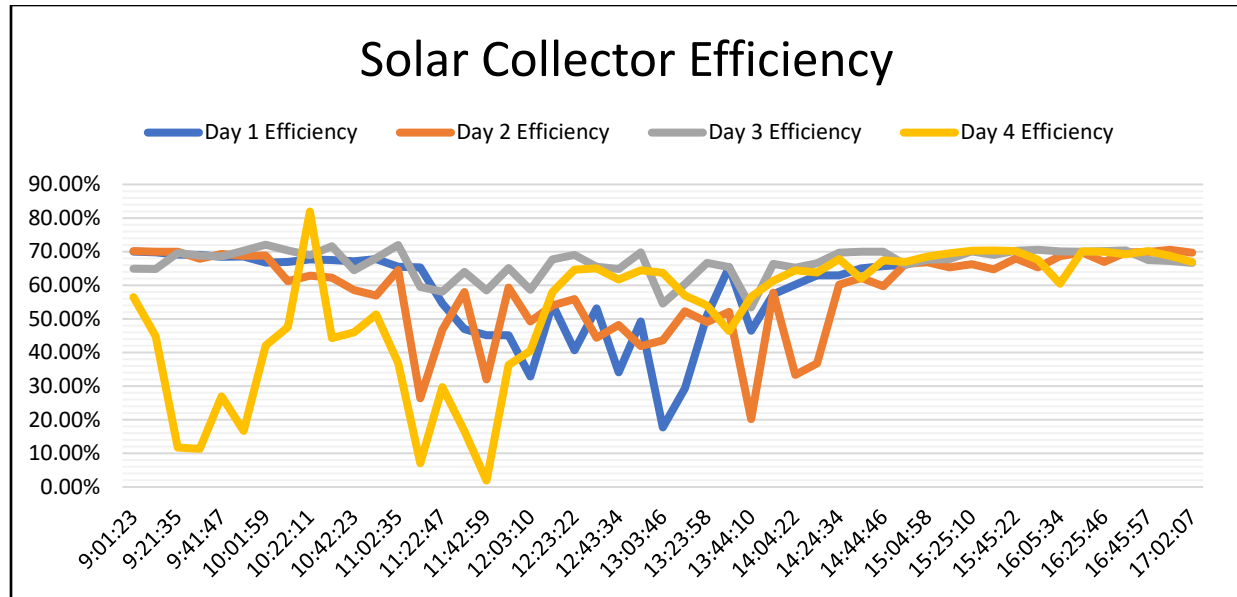

FIGURE 5. Solar Collector Efficiency Graph versus Time

Based on figure 5, it can be seen that the efficiency of each minute changes like a typical mechanical device. As for this solar collector, its efficiency fluctuates according to the large and small value of the incoming and outgoing temperatures received. And the highest solar collector efficiency is at 79.76% on day 3.

Solar Chimney Efficiency

The efficiency of solar chimney can be determined by the following equation [5]:

$$\eta = \frac{\dot{m}C_f(T_{f,o} - T_{f,i})}{H W L} \times 100\% \quad (3)$$

information :

- η = Chimney Efficiency
- \dot{m} = Mass flow rate (kg/m³)
- $T_{f,o}$ = Air Temperature Out (K)
- $T_{f,i}$ = Incoming Air Temperature (K)
- W = Chimney Diameter (m)
- L = Chimney Height (m)
- H = Solar radiation (W/m²)

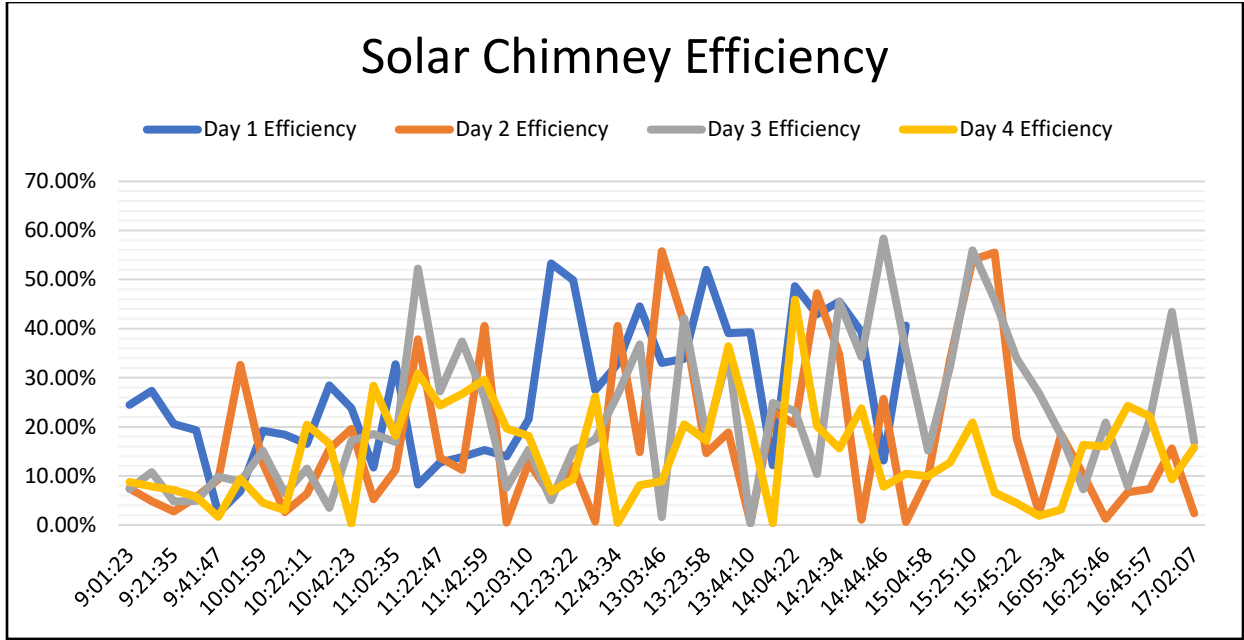

FIGURE 6. Solar Chimney Efficiency Graph versus Time

Based on figure 6, it can be seen that the efficiency of each minute changes like a typical mechanic device. As for this solar chimney, its efficiency fluctuates according to the large and small value of the incoming and outgoing temperatures received. The highest heat efficiency in the chimney was achieved at 58.38% on day 4.

Photovoltaic Efficiency

Photovoltaic efficiency can be determined by the following equations [6]:

$$\eta = \frac{P_{out}}{S_T A} \times 100\% \quad (4)$$

information :

- P_{out} = Maximum output power (Watt)
- S_T = Global solar radiations (W/m²)
- A = Surface area (m²)

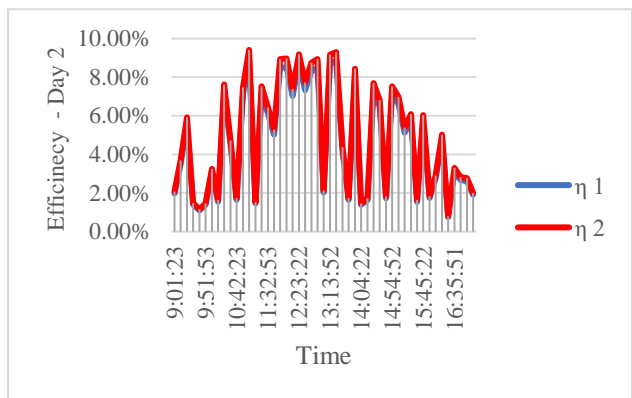
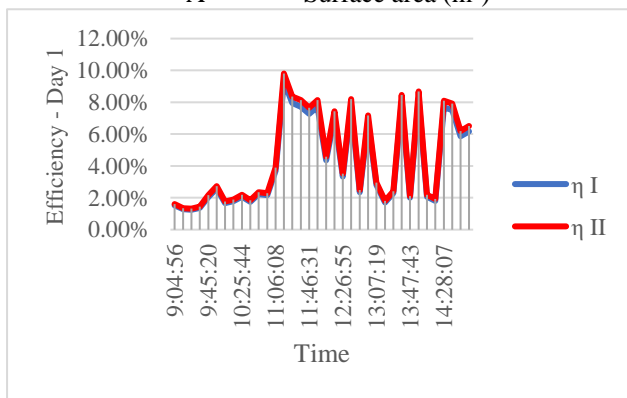

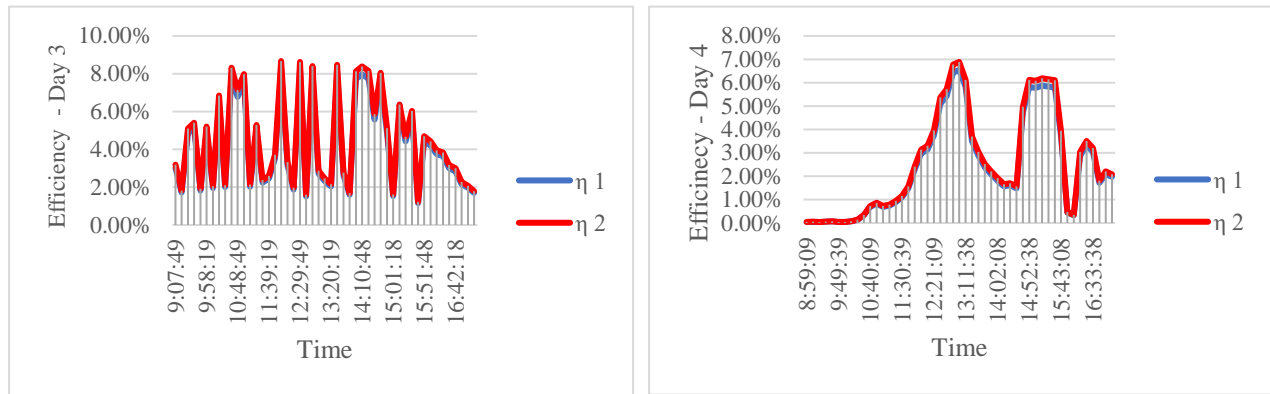

FIGURE 7.Photovoltaic Efficiency Graph versus Time

Based on figure 7, the efficiency of most photovoltaics is determined based on the intensity of the captured solar radiation. Photovoltaic efficiency fluctuates due to cloudy weather during testing. The highest efficiency was found on the 1st day, at 9.32% in the first photovoltaic and 9.80% in the second photovoltaic.

CONCLUSIONS

1. The highest output temperature value (T_{out}) at the entry air rate (T_{in}) of $V_{air} = 3$ m/s of 25.08°C for the experiment result with the incoming air temperature (T_{in}) was 27.02°C on day 2. While at the incoming airspeed, $V_{air} = 2$ m/s obtained the highest output temperature (T_{out}) for the experiment result of 26.04°C with the temperature of incoming air (T_{in}) is 27.00°C on day 4.
2. The highest effectiveness value at V_{air} air inflow rate = 3 m/s was 0.813, averaged 0.809, and the lowest 0.805 on day 1, while inbound airspeed $V_{air} = 2$ m/s obtained the highest of 0.772, an average of 0.768, and a low of 0.766 on day 3.
3. The highest solar collector efficiency was obtained by 79.76% at 10.23.34 WIB with an average of 66.84% and a low of 33.55% on day 3.
4. The highest chimney solar efficiency was obtained by 58.38% at 14.51.12 WIB on day 3, with an average efficiency of 21.99%. At the same time, the lowest efficiency was 0.22% at 10.40 WIB on day 4.
5. The highest output power in the first photovoltaic was obtained at 50.0385 Watts with an efficiency of 9.82% and in the second photovoltaic of 50.8443 watts with an efficiency of 10.33% at 11.31 WIB on day 2.

SUGGESTION

1. As is known the environmental conditions affect the effectiveness of the Earth-Air Heat Exchanger, good effectiveness in the use of this heat exchanger is during hot /sweltering environmental conditions.
2. EAHE performance can be maximized by adding pipe length as well as EAHE depth.
3. In future research, it is better to position solar collectors, solar chimneys and photovoltaics have better access to sunlight.

ACKNOWLEDGMENTS

This research is part of the basic research (PDUPT) activities of the second year DRPM DIKTI with the contract number: 4/UN5.2.3.1/PPM/KP-DRPM/2021.

REFERENCES

- [1] Ben Jmaa Derbel H, Kanoun O. Investigation of The Ground Thermal Potential in Tunisia Focused Towards Heating and Cooling Applications. *Appl Therm Eng* 2010;30:1091–100. <https://doi.org/10.1016/j.applthermaleng.2010.01.022>.
- [2] Bordoloi N, Sharma A, Nautiyal H, Goel V. An Intense Review on The Latest Advancements of Earth Air Heat Exchangers. *Renew Sustain Energy Rev* 2018;89:20. <https://doi.org/10.1016/j.rser.2018.03.056>.
- [3] Agrawal KK, Agrawal G Das, Misra R, Bhardwaj M, Jamuwa DK. A Review on Effect of Geometrical, Flow and Soil Properties on the Performance of Earth Air Tunnel Heat Exchanger. *Energy Build* 2018;176:58. <https://doi.org/10.1016/j.enbuild.2018.07.035>.
- [4] Hussein WKS, Said K. *Solar Energy Refrigeration by Liquid-Solid Adsorption Technique*. 2008.
- [5] Ong KS, Chow CC. Performance of a Solar Chimney. *Sol Energy* 2003;74:1–17. [https://doi.org/10.1016/S0038-092X\(03\)00114-2](https://doi.org/10.1016/S0038-092X(03)00114-2).
- [6] Messenger RA, Ventre J. *Photovoltaic Systems Engineering*. 2nd ed. 2005.